

9. Wyrażenia regularne i automaty skończone (1) – odpowiedzi

9.1.

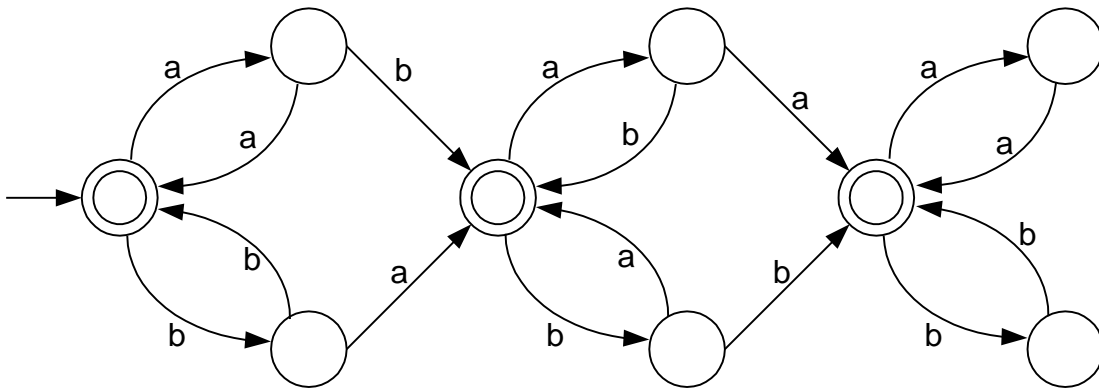

9.2.

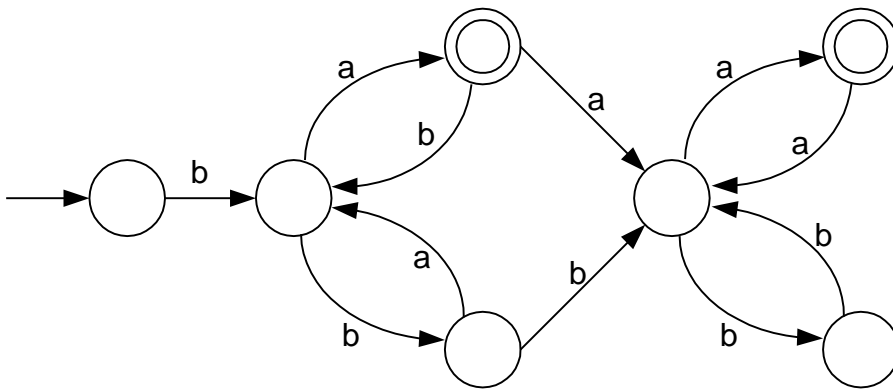

9.3.

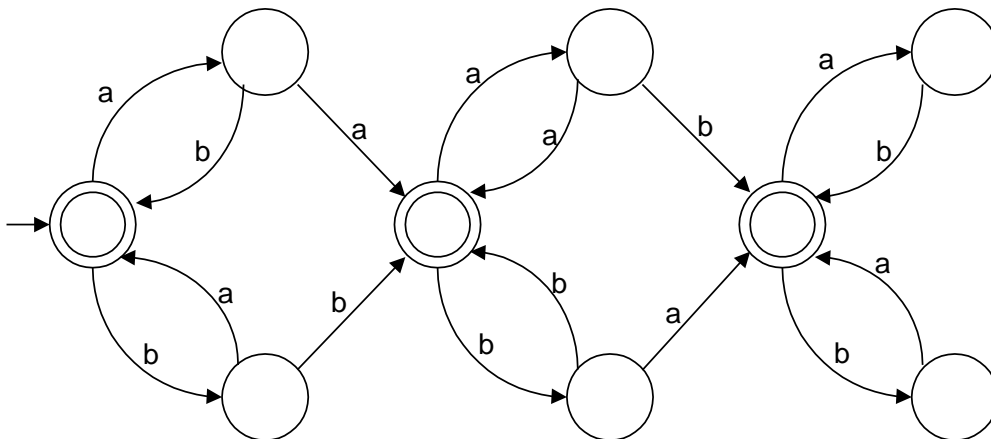

9.4.

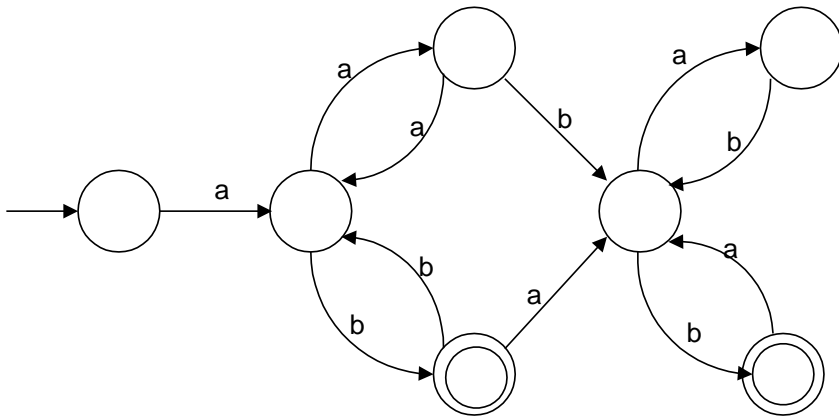

9.5.

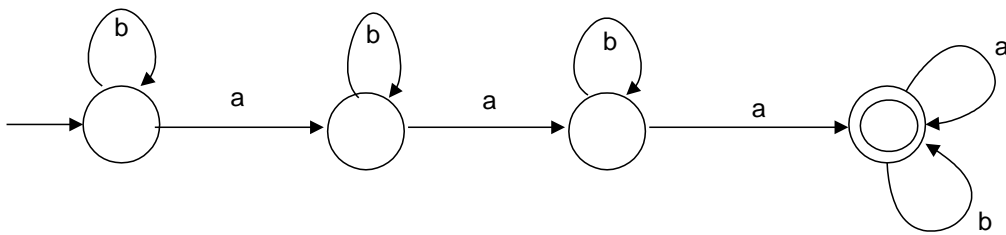

9.6.

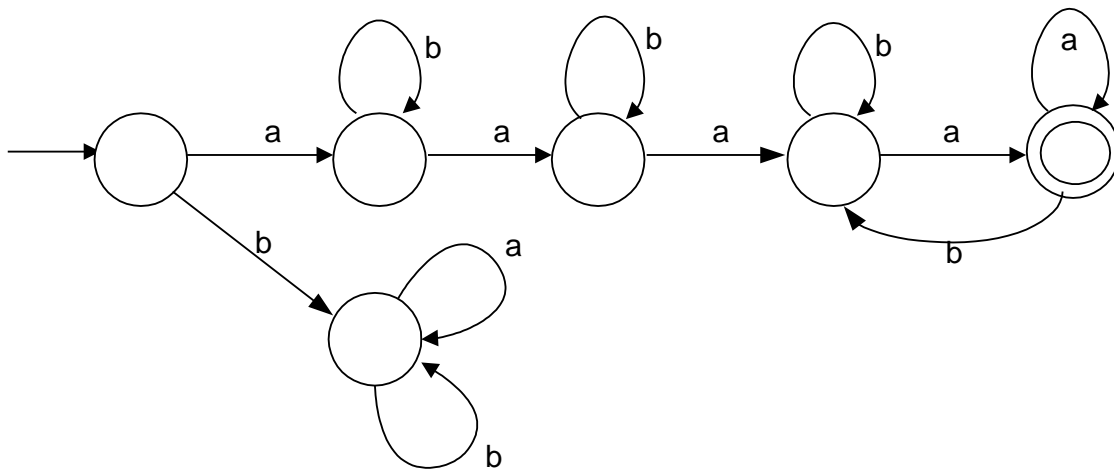

9.7.

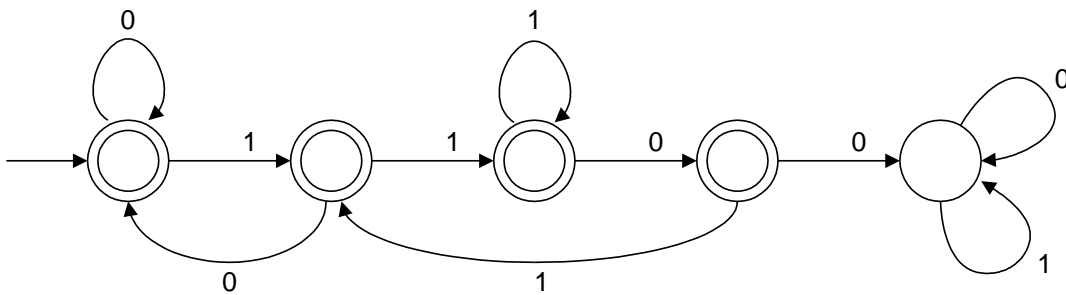

9.8.

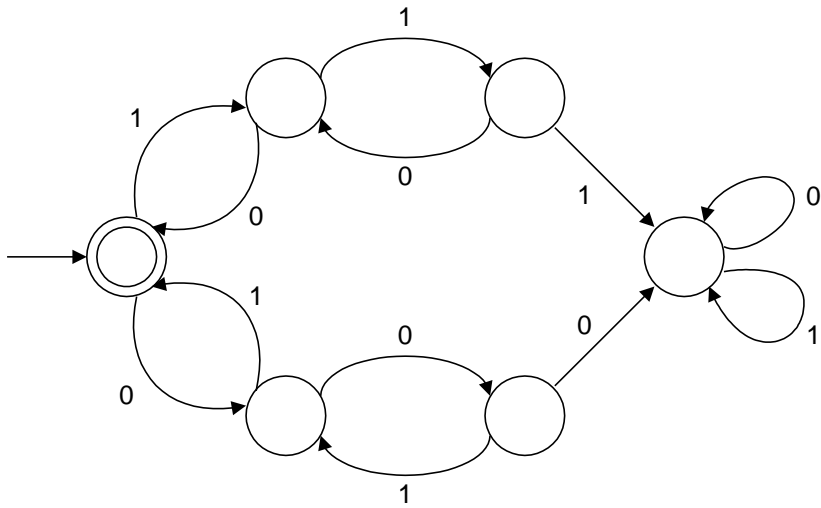

9.9.

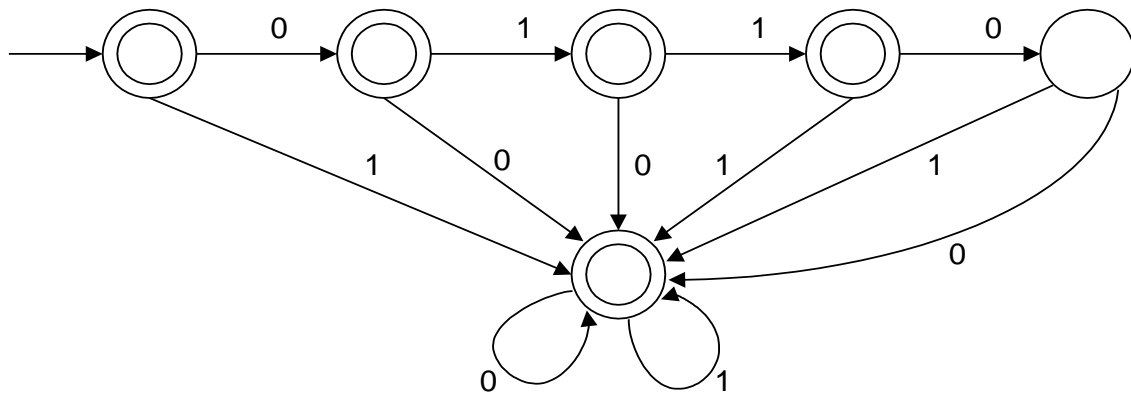

9.10.

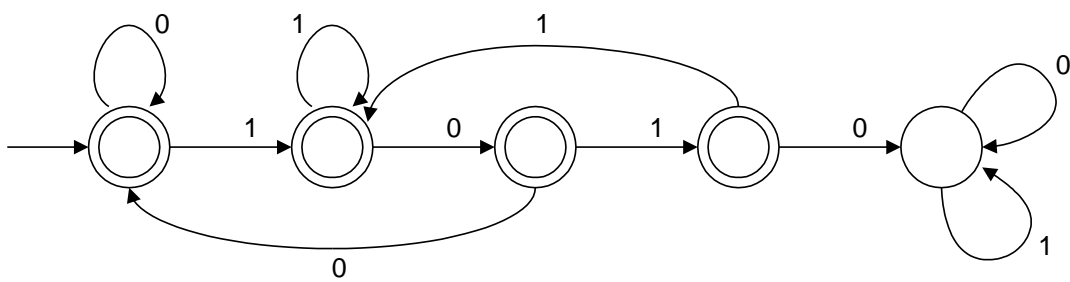

9.11.

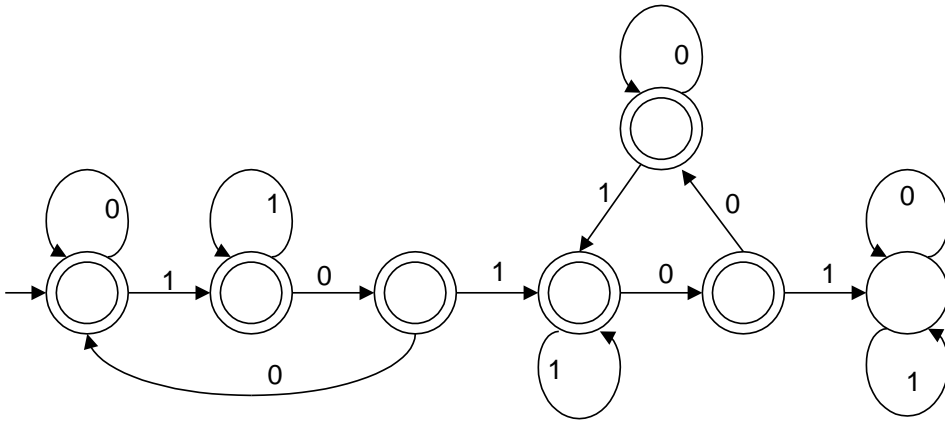

9.12.

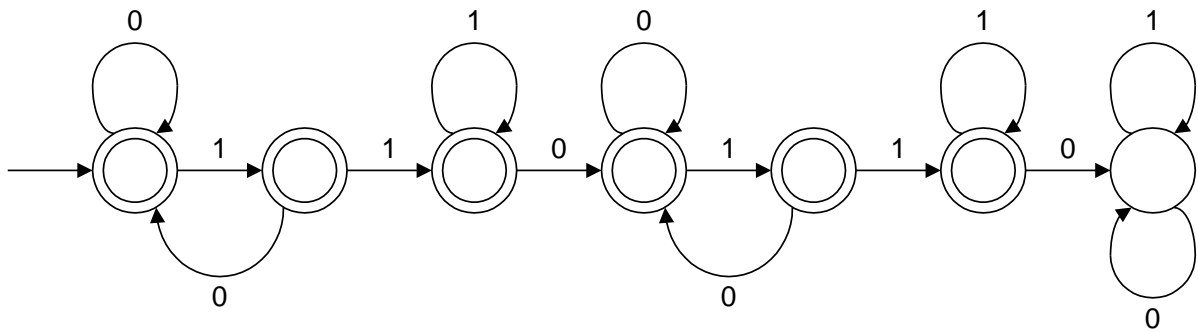

9.13.

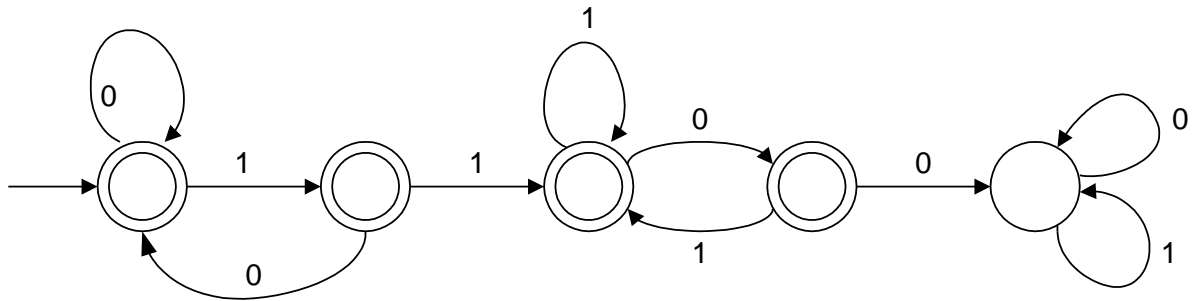

9.14.

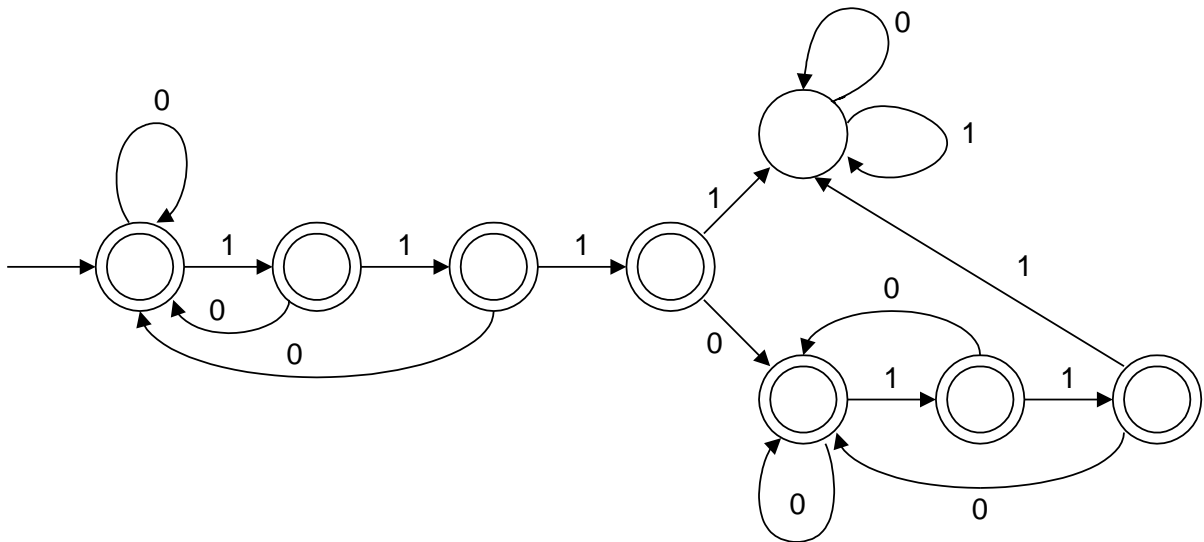

9.15.

Język nad alfabetem $\{a, b\}$ składający się ze słów kończących się symbolem b oraz zawierających co najmniej jeden symbol a .

automat niedeterministyczny i niepełny

automat deterministyczny i zupełny

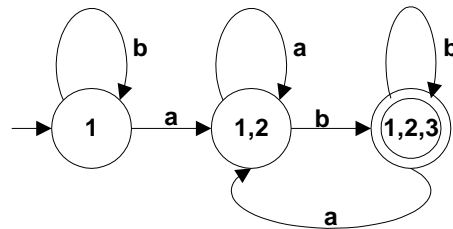
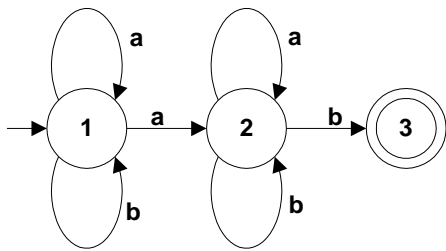

9.16.

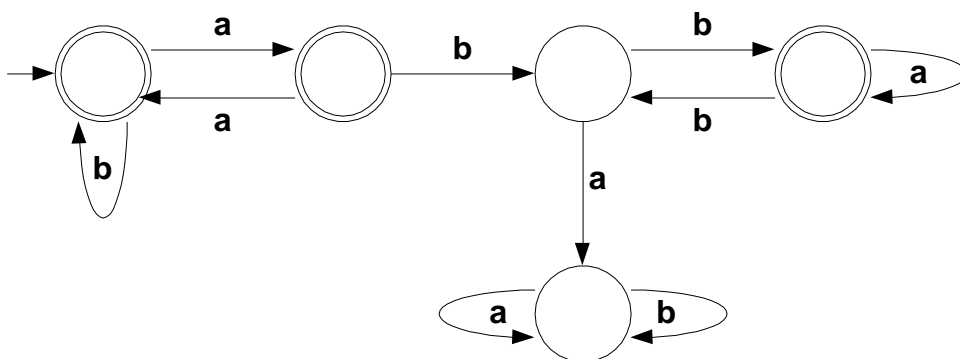

9.24.

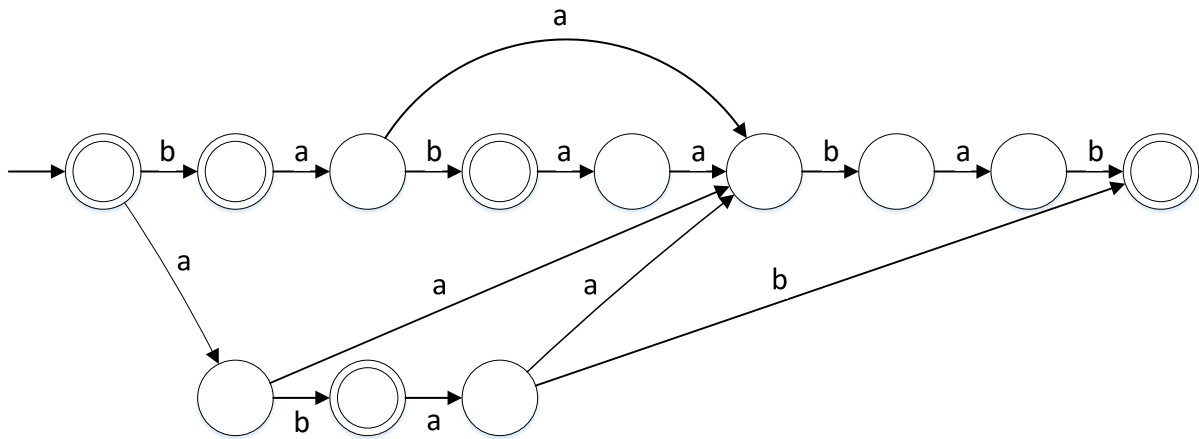

9.25.

