



US007060237B1

(12) **United States Patent**
Paine, Jr. et al.

(10) **Patent No.:** **US 7,060,237 B1**
(45) **Date of Patent:** ***Jun. 13, 2006**

(54) **NON-AQUEOUS BORATE ROUTES TO BORON NITRIDE**

(75) Inventors: **Robert T. Paine, Jr.**, Albuquerque, NM (US); **Gary L. Wood**, Valdosta, GA (US); **Jerzy F. Janik**, Woj. Malopolskie (PL); **William J. Kroenke**, Placitas, NM (US)

(73) Assignee: **Science & Technology Corporation @ UNM**, Albuquerque, NM (US)

(*) Notice: Subject to any disclaimer, the term of this patent is extended or adjusted under 35 U.S.C. 154(b) by 140 days.

This patent is subject to a terminal disclaimer.

(21) Appl. No.: **10/280,456**

(22) Filed: **Oct. 24, 2002**

Related U.S. Application Data

(63) Continuation-in-part of application No. 10/131,301, filed on Apr. 23, 2002, now Pat. No. 6,824,753.

(60) Provisional application No. 60/374,966, filed on Apr. 22, 2002.

(51) **Int. Cl.**
C01B 21/064 (2006.01)
C01B 35/10 (2006.01)

(52) **U.S. Cl.** **423/277; 423/290**

(58) **Field of Classification Search** **423/277, 423/290**

See application file for complete search history.

(56) **References Cited**

U.S. PATENT DOCUMENTS

2,629,732 A 2/1953 Schechter

2,824,787 A 2/1958 May et al.
3,352,637 A 11/1967 Heymer et al.
3,711,594 A 1/1973 Bienert et al.
4,784,978 A 11/1988 Ogasawara et al.
4,971,779 A 11/1990 Paine, Jr. et al.
6,348,179 B1 2/2002 Paine, Jr. et al.

FOREIGN PATENT DOCUMENTS

DE 2004360 8/1971
DE 1943581 3/1972
DE 1943582 3/1972
EP 0396448 11/1990
JP 60-200811 A 3/1984
JP 60-200811 10/1985

OTHER PUBLICATIONS

Bienert, K., et al., ABSTRACT No. 101255 "Boron-Nitrogen-Hydrogen Compounds." *Industrial Inorganic Chemicals*. vol. 74 (1971). p. 101265, (no month).

(Continued)

Primary Examiner—Wayne A. Langel

(74) *Attorney, Agent, or Firm*—Min, Hsieh & Hack LLP

(57) **ABSTRACT**

A non-aqueous route and process for preparation of boron nitride utilizing aerosol assisted vapor phase synthesis (AAVS) wherein boron precursors are nitrated in one or two heating steps, and wherein a boron oxide nitride carbide intermediary composition is formed after the first heating step and may be further nitrated to form resultant spheroidal boron nitride powders including spheroidal particles that are smooth, bladed, have protruding whiskers, and are of turbostratic or hexagonal crystalline structure, specifically wherein the boron precursor is dissolved in a non-aqueous solution prior to aerosolization.

56 Claims, 12 Drawing Sheets

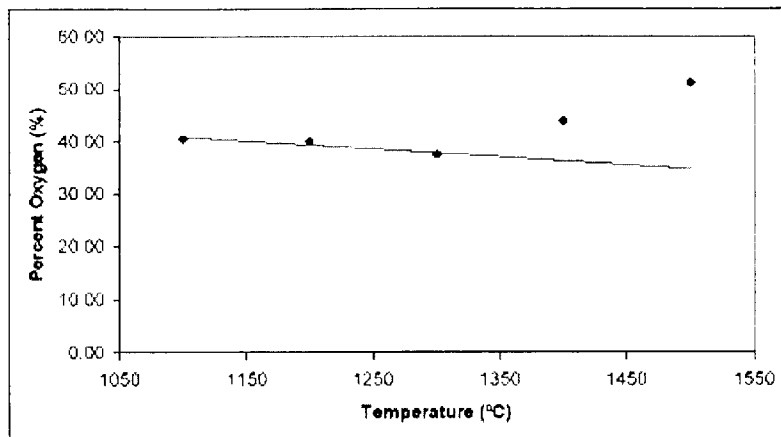

Oxygen Content of BN_xO_y Powders Versus Reactor Temperature from AAVS Reaction of Aqueous H_3BO_3 and NH_3

OTHER PUBLICATIONS

- Bienert, K., et al., ABSTRACT No. 101256 "Boron Nitride," *Industrial Inorganic Chemicals*, vol. 74 (1971), p. 101265, (no month).
- Bienert, K., et al., ABSTRACT No. 102908 "Boron Nitride," *Electronic Phenomena*, vol. 75 (1971) p. 102909, (no month).
- Goubeau, J., et al., *Z. Anorg. Allgem. Chem.* vol. 266, pp. 161-174 with rough translation (1951), (no month).
- Lappert, M.F., CHAPTER, *Organic Compounds of Boron*, *Chem. Rev.*, vol. 56, p. 959 (1956), (no month).
- Lindquist, D.A., et al., "Boron Nitride Powders Formed by Aerosol Decomposition of Poly(borazinylamine) Solutions" *J. Am. Ceram. Soc.*, vol. 74, No. 12, pp. 3426-3428 (1991), (no month).
- Murakawa, N., et al., ABSTRACT No. 53023 "Boron Nitride Manufacture." *JP Patent 60-200,811* (Oct. 11, 1985).
- Paine, R.T., et al., "Synthetic Routes to Boron Nitride." *Chem. Rev.*, vol. 90 pp. 72-91 (1990), (no month).
- Pruss, E.A., et al., "Aerosol Assisted Vapor Synthesis of Spherical Boron Nitride Powders." *Chem of Materials*, vol. 12, No. 1, pp. 19-21 (2000), (no month).
- Steinberg, H., Chapter 4, *Organoboron Chemistry*, J. Wiley and Sons 1963, (no month).
- Wade, B., et al., "Synthesis and Characterization of Processable Polyborate Precursors," *J of Sol-Gel Sci and Tech.* vol. 5, pp. 15-25 (1995), (no month).

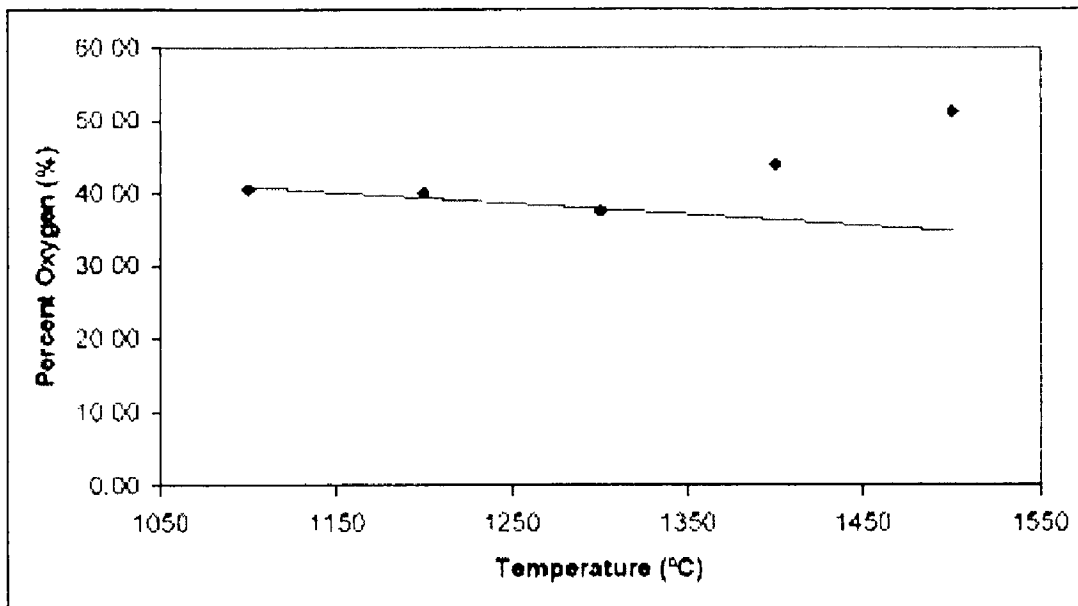

Figure 1 Oxygen Content of BN_xO_y Powders Versus Reactor Temperature from AAVS Reaction of Aqueous H_3BO_3 and NH_3

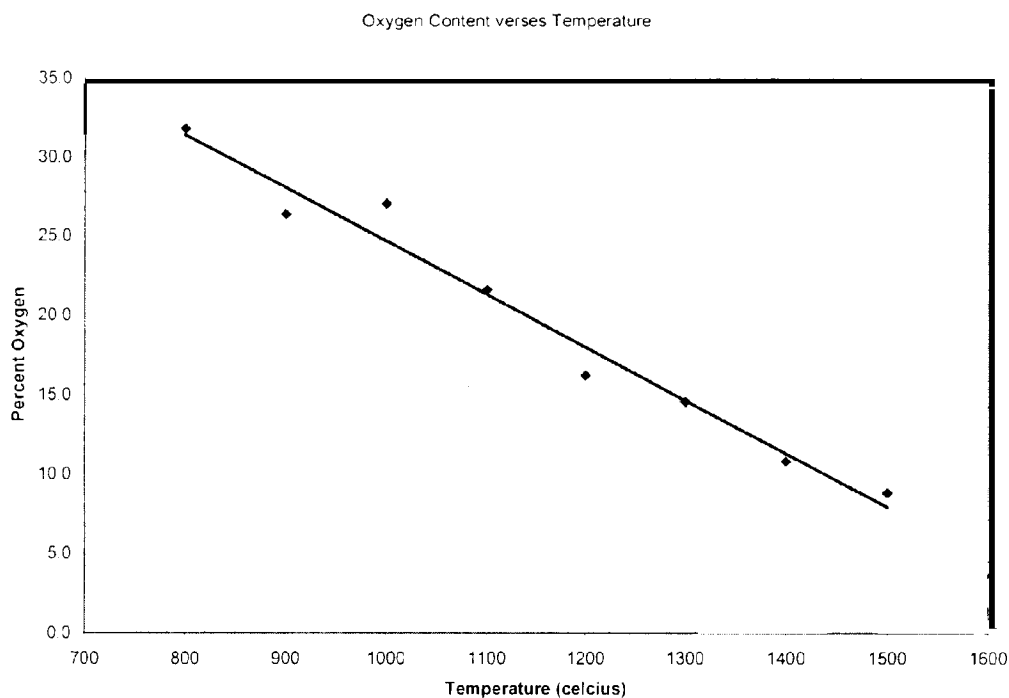

Figure 2. $BN_xO_yC_z$ Powder Oxygen Concentration (% wt.) v.s. AAVS Process Temperature
($N_2 = 1$ L/min, $NH_3 = 3$ L/min) Powder generated from AAVS Reaction between
 $(MeO)_3B$ and NH_3 .

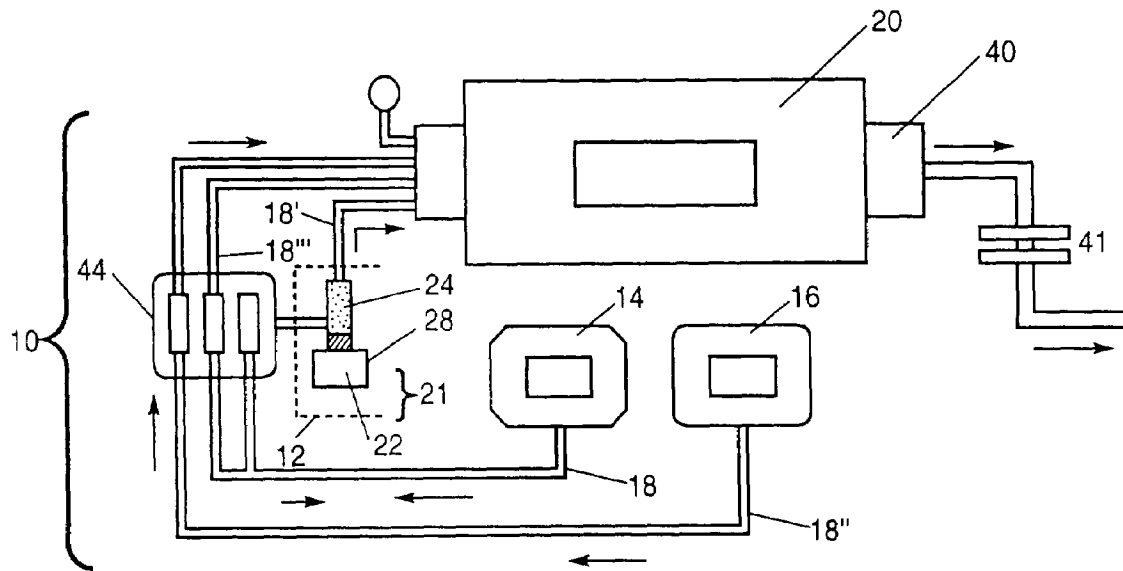

FIG-3

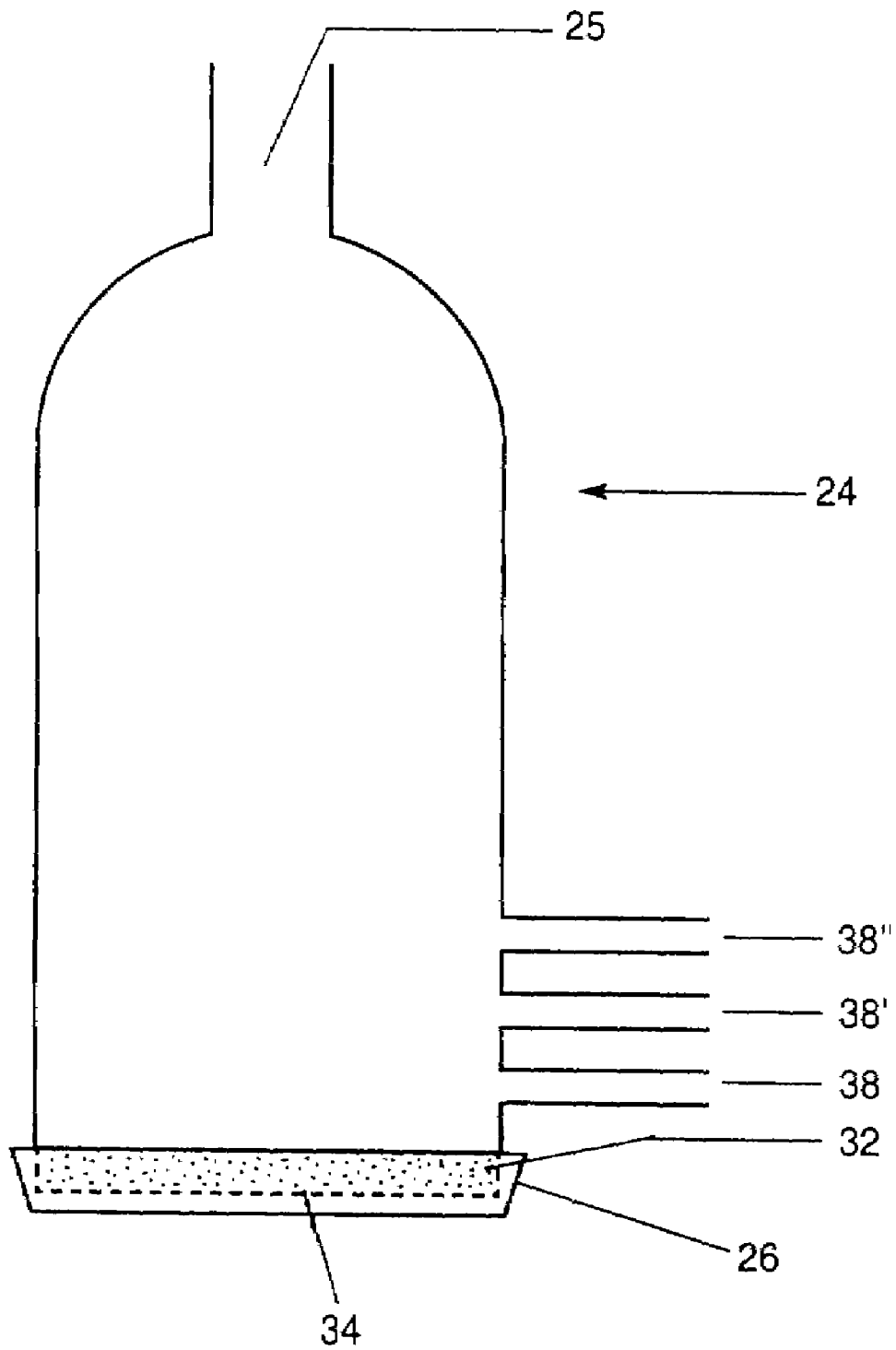

FIG-4

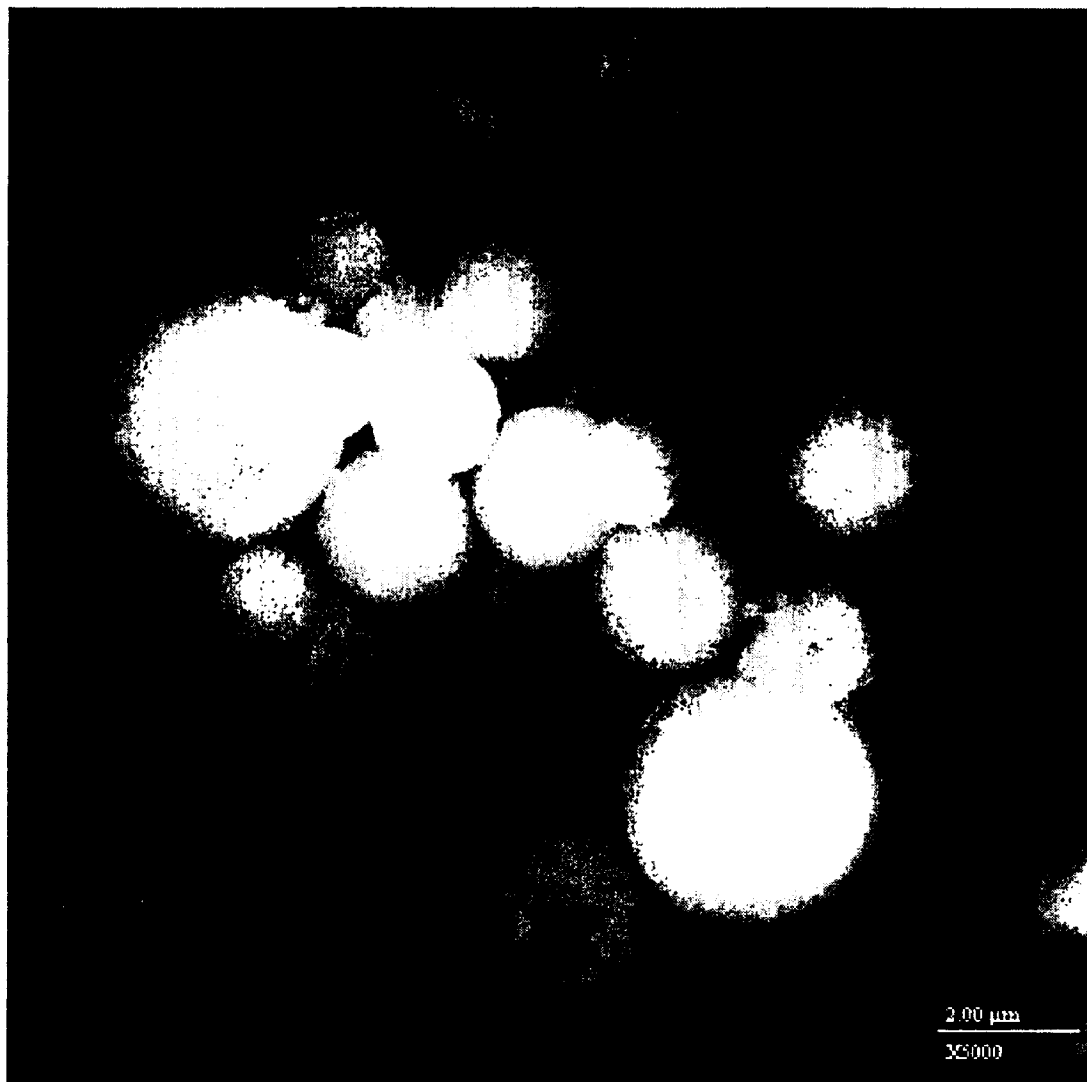

Fig. 5 SEM of BN_xO_yC_z Powder

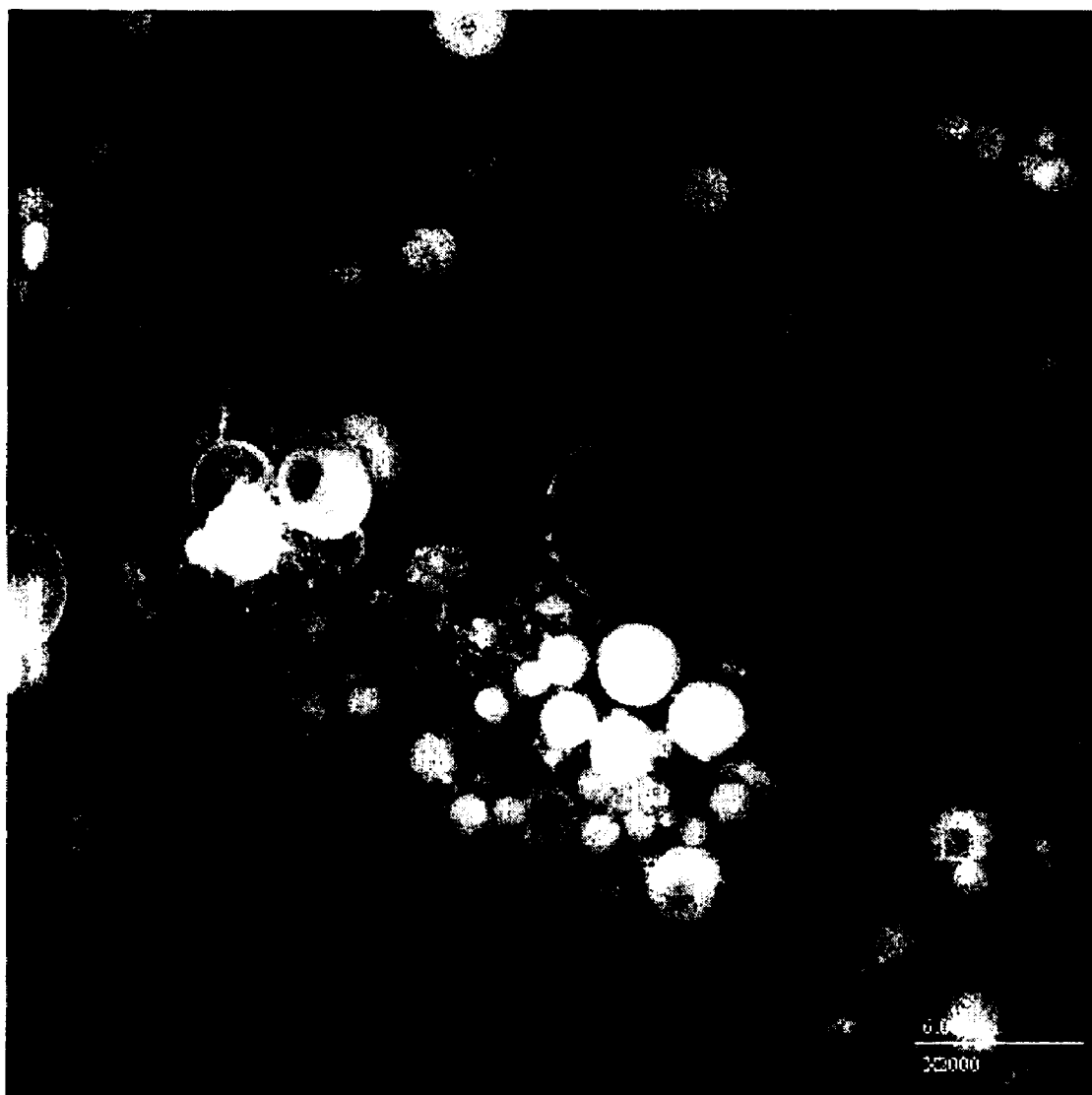

Fig. 6 SEM of BN_xO_yC_z Powder

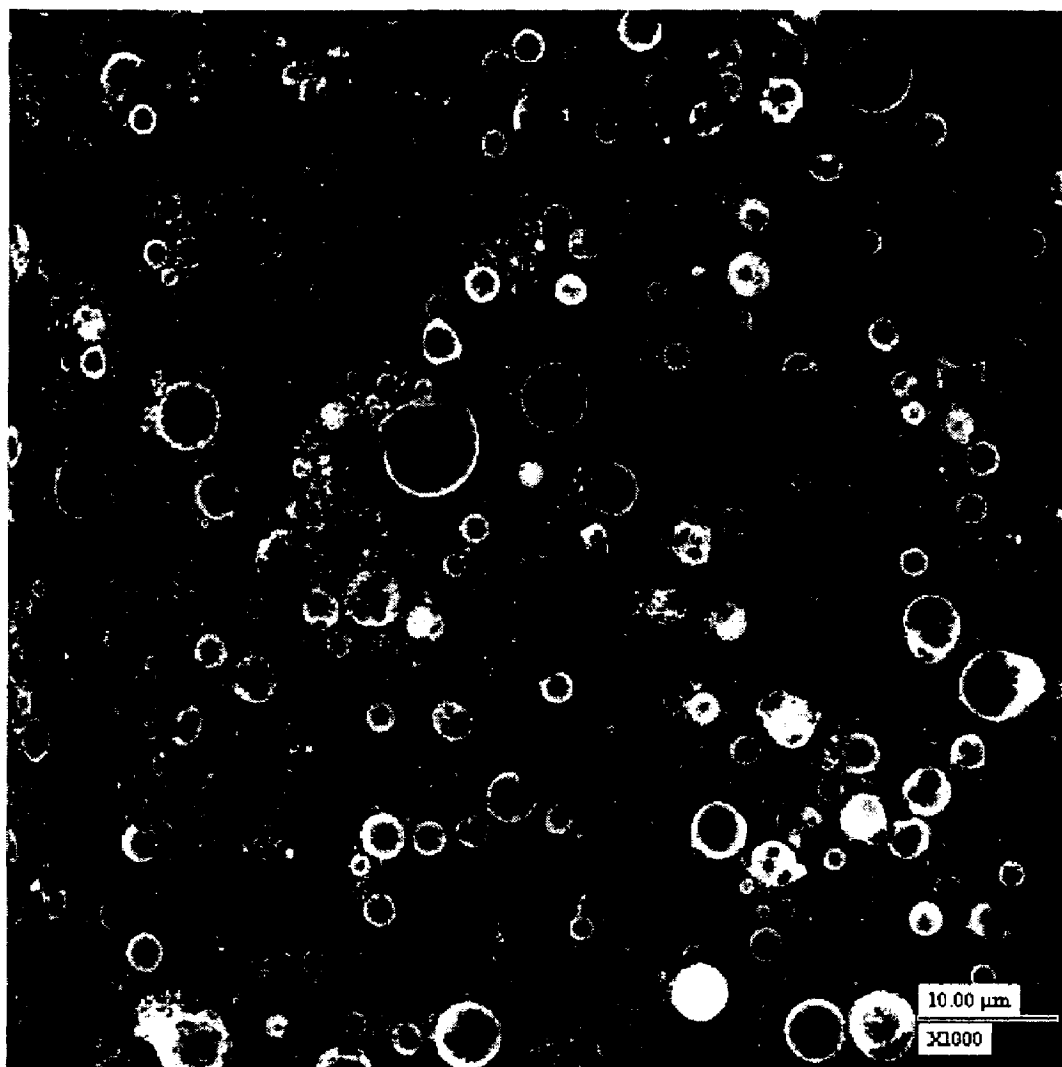

Fig. 7. SEM of BN_xO_yC_z Powder

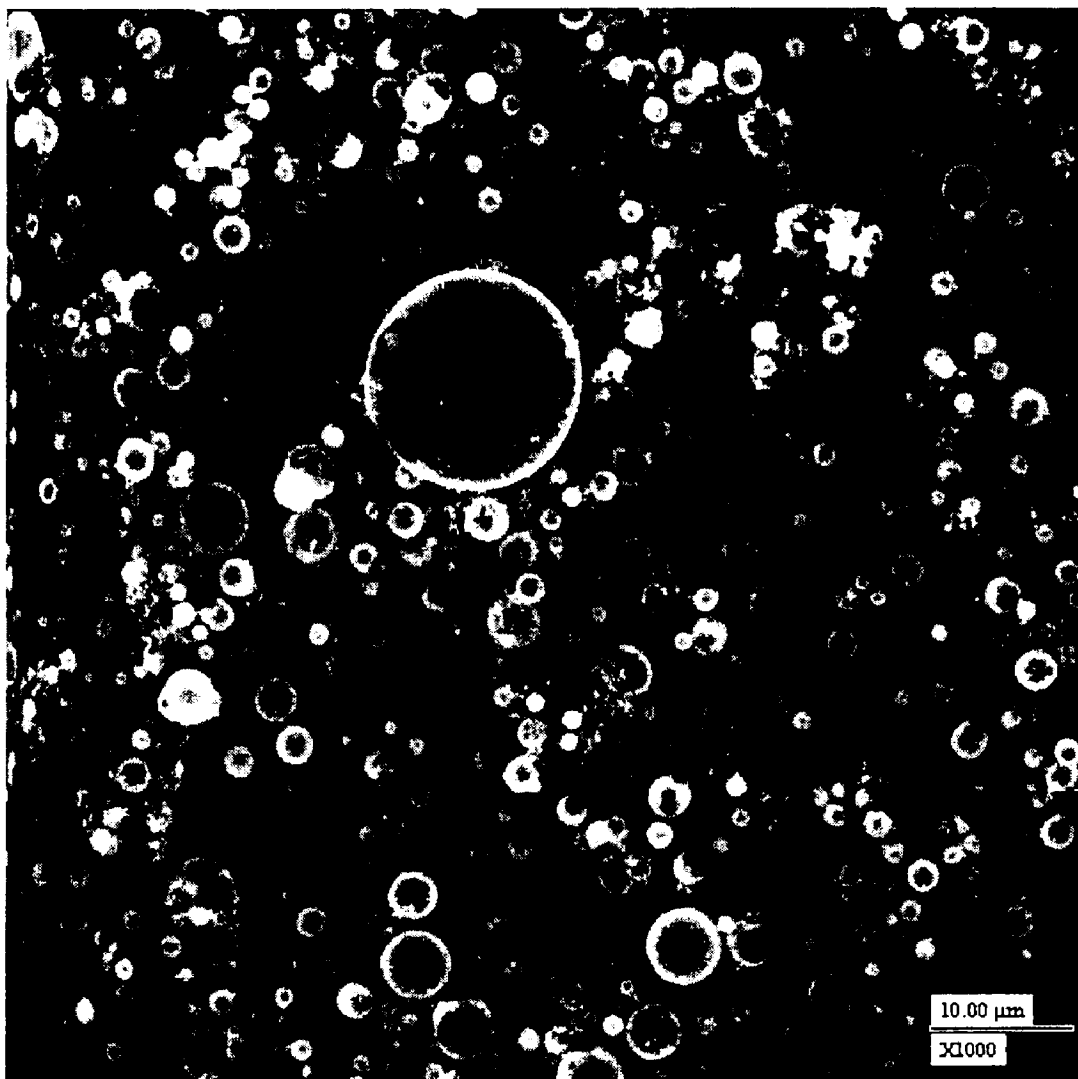

Fig. 8 SEM of BN_xO_yC_z Powder

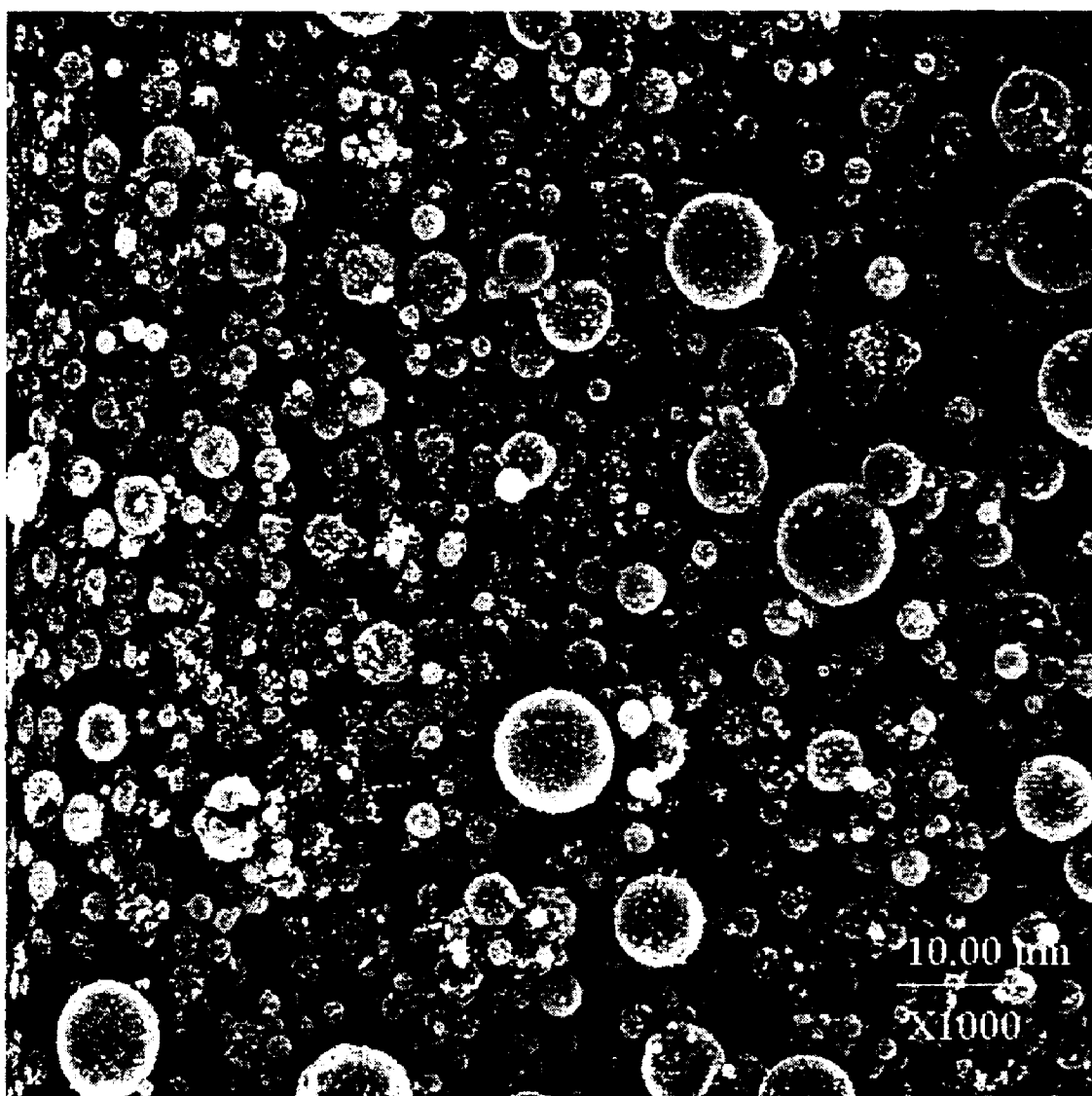

Fig. 9 SEM of $BN_xO_yC_z$ Powder

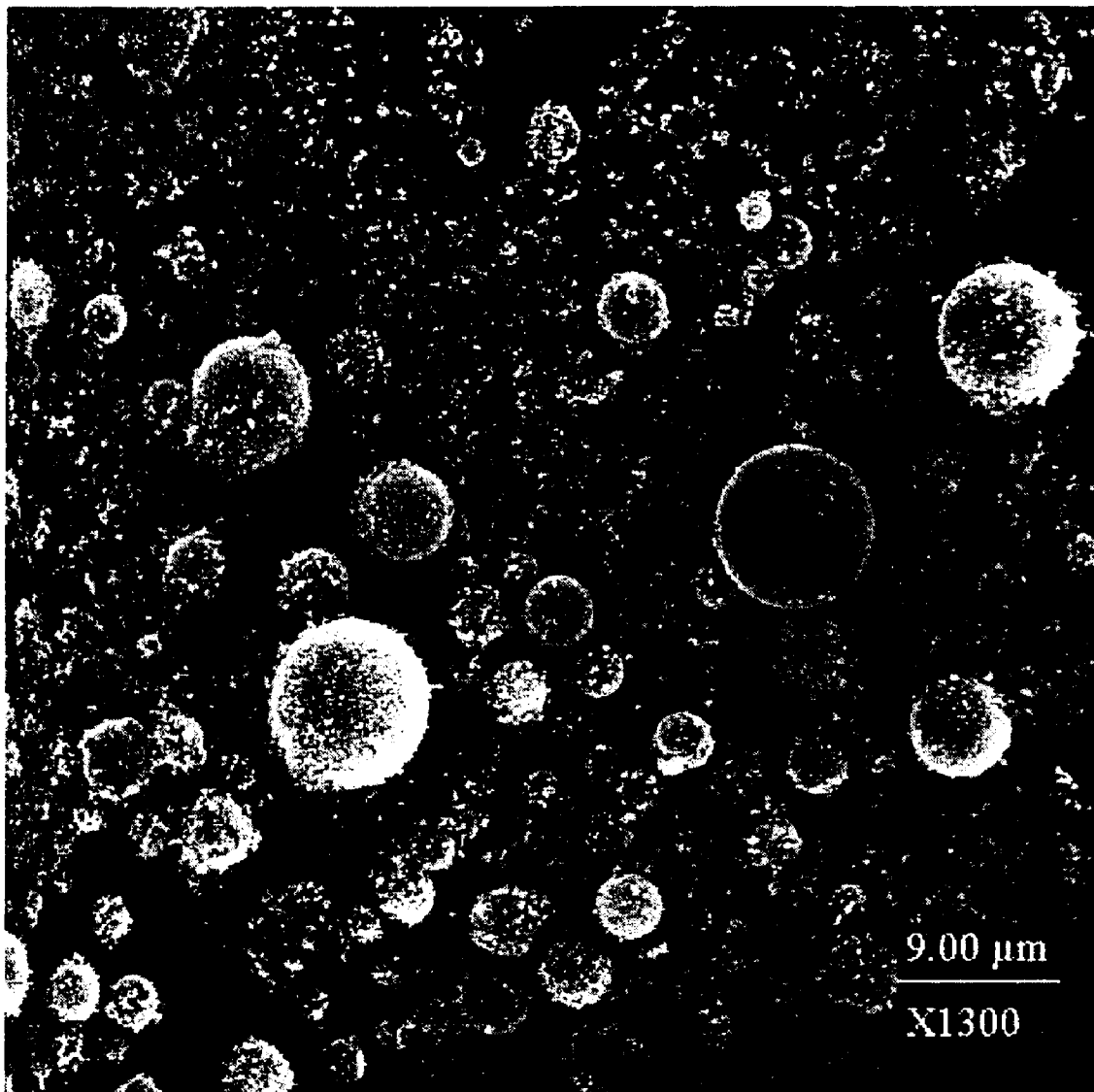

Fig. 10 SEM of BN_xO_yC_z Powder.

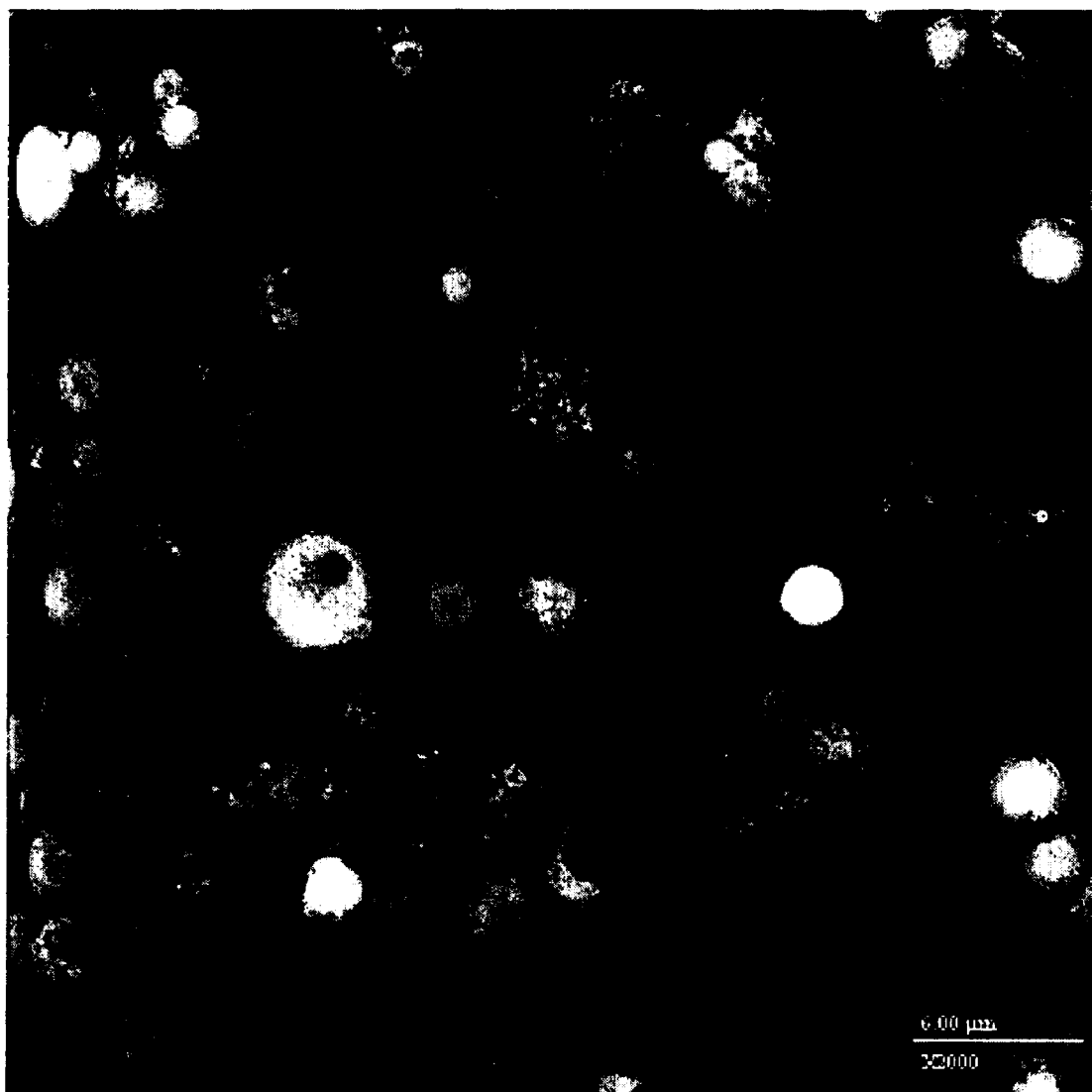

Fig. 11. SEM of BN_xO_yC_z Powder

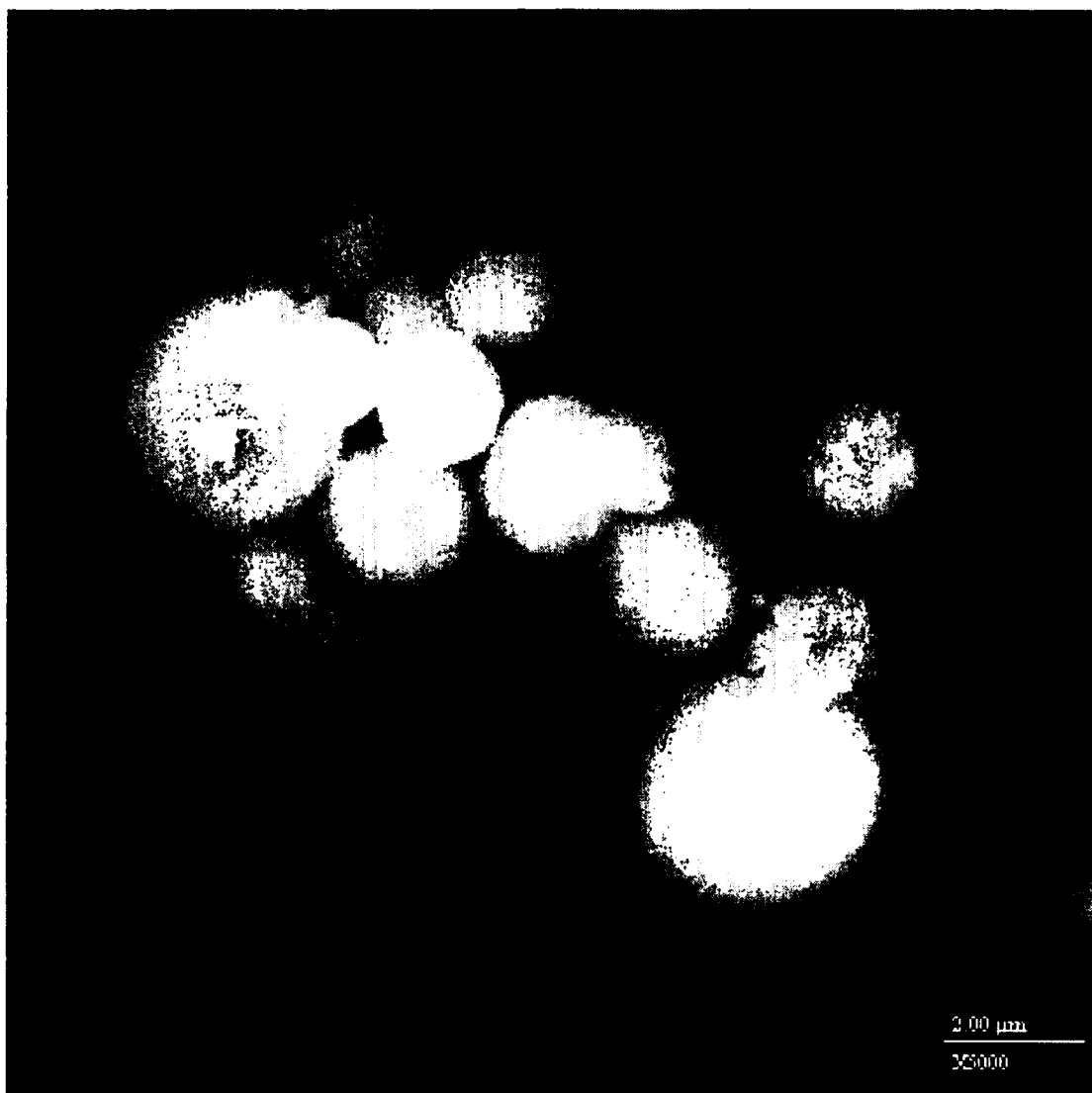

Fig. 12 SEM of BN Powder

NON-AQUEOUS BORATE ROUTES TO BORON NITRIDE

CROSS-REFERENCE TO RELATED APPLICATIONS

This application claims the benefit of the filing of U.S. Provisional Patent Application Ser. No. 60/374,966, entitled "NON-AQUEOUS BORATE ROUTE TO BORON NITRIDE," filed on Apr. 22, 2002, and the specification thereof is incorporated herein by reference. This application is also a continuation-in-part application of U.S. patent application Ser. No. 10/131,301, entitled "Organoboron Route and Process for Preparation of Boron Nitride," filed Apr. 23, 2002, U.S. Pat. No. 6,824,753.

GOVERNMENT RIGHTS

The U.S. Government has a paid-up license in this invention and the right in limited circumstances to require the patent owner to license others on reasonable terms as provided for by the terms of Contract Nos CHE9508668 and CHE9983205 awarded by the National Science Foundation.

COPYRIGHTED MATERIAL

A portion of the disclosure of this patent document and of the related application listed above contains material that is subject to copyright protection. The owner has no objection to the facsimile reproduction by anyone of the patent document or the patent disclosure, as it appears in the Patent and Trademark Office patent file or records, but otherwise reserves all copyrights whatsoever.

BACKGROUND OF THE INVENTION

1. Field of the Invention (Technical Field)

The present invention relates to a procedurally simple, low cost, potentially continuous process for production of boron nitride powders exhibiting smooth spherical morphology, spheroidal particles with "bladed" surface morphology, spheroidal particles with protruding "whiskers," and fully "bladed" particles with platelet morphology, and particles having turbostratic or hexagonal crystal structure. The process utilizes an aerosol assisted vapor phase synthesis (AAVS) wherein non-aqueous based or partially aquated aerosol droplets containing boron precursors are nitrated through a boron oxide nitride carbide intermediary composition to form spherical and modified spherical boron nitride powders. The process can be achieved through use of an aerosol assisted vapor phase reactor system (AAVRS) or related spray/mist pyrolysis reactor system. It has significant use in preparation of the preferred spheroidal boron nitride powders for use in the microelectronic, polymer, and cosmetic industries as well as in traditional ceramic markets (e.g., aerospace and automotive products).

2. Background Art

Boron nitride (BN) is a commercially produced refractory non-oxide ceramic material whose properties are highly dependent on its crystalline structure. The most common structure for BN is a hexagonal crystal structure (h-BN). This structure is similar to the graphitic structure of carbon, and consists of extended two-dimensional layers of edge-fused six-membered (BN)₃ rings. The layers arrange so that B atoms in the rings in one layer are above and below N atoms in neighboring layers and vice versa (i.e., the rings are shifted positionally with respect to layers). The intraplanar

B—N bonding within layers in the fused six-membered rings is strongly covalent while the interplanar B—N bonding is weak, similar to graphite. The layered, hexagonal crystal structure results in anisotropic physical properties that make this material unique in the overall collection of non-oxide ceramics.

From the commercial standpoint, h-BN is typically obtained as a powder, most often from multi-step processes employing boric oxide, sodium borate, or boric acid (as the boron raw material) and urea, melamine, and/or ammonia (as the nitrating source). In its powder form, BN can be processed by classical powder-forming methods into simple and complex shapes. Such powders are often hot-pressed in the fabrication of finished articles. Since it is soft, the hot pressed, processed bodies can be easily machined. BN is also obtained by chemical vapor deposition (CVD) growth, referred to as "pyrolytic" BN.

Pyrolytic BN is considered the most typical form of BN in the industry, given the absence of binders and improved crystallinity and grain features. As a result, unless otherwise indicated, properties of BN described in these background materials are representative of pyrolytic BN. Under standard solid state synthesis conditions, BN is typically obtained as a mixture of meso-graphitic and turbostratic modifications that contain varying degrees of disorder of the ideal hexagonal BN structure (h-BN). Fully ordered h-BN is only obtained with careful attention to synthetic detail. (Paine, RT, Narula, CK. Synthetic Routes to Boron Nitride. *Chem. Rev.* 90 73–91, 1990.)

All of the syntheses are driven by the thermodynamic stability of BN (in the absence of oxygen and moisture, BN is stable above 2000° C. in N₂) and the reducing nitridation conditions that remove impurities. (Paine RT, Narula, CK. Synthetic Routes to Boron Nitride. *Chem. Rev.* 90 73–91 1990.) Carbothermal reduction conditions can also be employed to remove impurity oxygen. Commercial powder producers manipulate reaction conditions in order to achieve target powder purity, grain size, sinterability, and crystallinity. These features, in turn, influence powder processibility and finished product performance. It is important to note that commercial powders are usually obtained with primary particles having a platelet morphology, a macroscopic manifestation of the inherent crystal structure of h-BN, or as primary particle agglomerates having irregular morphology.

Commercial applications for h-BN are well established in several traditional ceramic markets. In particular, the high temperature stability, chemical inertness, lubricity, electrical resistivity and thermal conductivity make BN powders ideal for fabrication of products used in aerospace, automotive and microelectronic products, including large crucibles, heat sinks, mold liners and electrical insulators.

Recently, interest has arisen in inorganic ceramic/organic polymer composites containing BN powders for thermal management applications. It has been suggested in the art that a spherical morphology BN powder would be useful to enhance powder processing of polymers. However, a commercial source of such powders is not available. One known process to obtain small, laboratory-scale samples of spheroidal BN involves reacting trichloroborazine with an aminosilane to form a polymer, poly(borazinylamine), that dissolves in liquid ammonia (NH₃). The resulting solution is used to form an aerosol that is passed through a reaction furnace, producing a boron nitride powder composed of primary particles having spherical morphology. Further

nitridation in an NH_3 atmosphere at a temperature of 1600° C., over a period of time of at least eight hours, gives h-BN particles of overall spheroidal shape with protruding non-uniform blades. This process is not commercially viable since it requires the use of an expensive, commercially unavailable polymer that is made only from an expensive commercially unavailable monomer. (Lindquist, DA et al. Boron Nitride Powders Formed by Aerosol Decomposition of Poly(borazinylamine) Solutions. *J. Am. Ceram. Soc.* 74 (12) 3126–28, 1991).

As another example, a second method reacts boron trichloride with ammonia, a combination typically used to make platelet morphology h-BN by CVD. The resulting powders are treated at high temperature in a graphite furnace under vacuum. (The patent suggests formation of spherical primary particles although no evidence of the actual morphology is provided.) This process, if successful, is not commercially attractive due to the expense of the starting material, BCl_3 , and the formation of a corrosive by-product HCl that tends to leave chloride impurities in powders. (EPO No 0 396 448)

A third and potentially more practical approach for the formation of spherical morphology h-BN powders utilizes a process where an aerosol is generated from a saturated (0.9M) aqueous solution of boric acid. The aerosol is passed into a heated tubular reactor where it is nitrided by NH_3 in a temperature range of between 600° C. and 1500° C., preferably between 1000° C. and 1200° C. A powder product, BN_xO_y , is collected that contains significant amounts of oxygen, typically between 40 wt. % to 55 wt. %. The primary particles have spherical particle diameters in the range 0.1 micron to 5 microns. These powders are subsequently nitrided in a second stage in a temperature range of between 1000° C. to 1700° C. under a flowing stream of NH_3 . The oxygen contents of the resulting boron nitride powders are less than 4 wt. % and the particles retain the spherical morphology (Pruss et al, Aerosol Assisted Vapor Synthesis of Spherical Boron Nitride Powders. *Chem. Mater.* 12(1), 19–21, 2000; U.S. Pat. No. 6,348,179 to Pruss et al.)

Although the process described by Pruss et al. is practically useful for the production of spherical morphology BN powders, it possesses several drawbacks, including: (a) large amounts of water are injected into the tubular reaction zone in the form of aerosol droplets thereby diluting the NH_3 reactant that is required for nitridation of H_3BO_3 dissolved in the aqueous aerosol droplets, (b) the large amounts of injected water act as a back-reactant with BN_xO_y aerosol powders; (c) water is also formed as a reaction byproduct in the first stage aerosol nitridation; (d) the BN_xO_y powders formed in the first-stage nitridation reaction contain large amounts of oxygen; (e) the large amounts of oxygen are difficult to remove in the second-stage nitridation; and (f) there is significant loss of boron as a volatile component during the nitridation process. FIG. 1 illustrates that large amounts of water are deleterious to the nitridation process. Specifically, as expected, at constant gas flow rates and NH_3/N_2 ratios, the amount of oxygen present in BN_xO_y powders decreases with increasing reactor temperature from $T=600^\circ\text{C}$. to 1300°C . However, above $T=1300^\circ\text{C}$., the amount of oxygen in the BN_xO_y powder dramatically increases as a result of a back-reaction between BN_xO_y and steam or its thermal decomposition products. Due to such drawbacks, alternative solventless or non-aqueous solvent-based aerosol chemical systems have been sought in the industry.

Very few readily available, inexpensive boron reagents exist that are soluble in a non-aqueous solvent appropriate for aerosol formation or aerosol pyrolysis. Similarly, there are very few inexpensive, liquid-phase boron reagents that might be employed directly without a solvent to generate an aerosol. However, at least one family of boron reagents does exist that is commercially available in large quantities at relatively low cost and is soluble in non-aqueous solvents: trialkoxyboranes or trialkylborates, $(\text{RO})_3\text{B}$ (e.g., $\text{R}=\text{Me}$ (CH_3), Et (C_2H_5), Pr (C_3H_7), Bu (C_4H_9)). These are free-flowing liquids at 23° C. In addition, there is evidence in the literature that suggests that trialkylborates, $(\text{RO})_3\text{B}$, react with the common nitriding reagent ammonia, NH_3 .

For example, U.S. Pat. No. 2,629,732, discloses that $(\text{RO})_3\text{B}$ ($\text{R}=\text{lower mol. wt. alkyl groups, preferably CH}_3$) reacts with NH_3 in a 1:1 ratio in the gas phase at normal atmospheric pressure and temperature to give adducts, $(\text{RO})_3\text{B}\cdot\text{NH}_3$. Further, other examples in the literature describe a reaction of $(\text{MeO})_3\text{B}$ with NH_3 that is claimed to form an adduct $(\text{MeO})_3\text{B}\cdot\text{NH}_3$ that sublimates at 45° C. and allegedly is stable to at least 375° C. (Goubeau et al., *Z. Anorg. Allgem. Chem.* 266, 161–174, 1951). Goubeau et al. also describe reactions that employ other reactant ratios which produce complex product mixtures that are not identified. The chemistry is proposed to involve elimination of methanol and dimethyl ether. U.S. Pat. No. 2,824,787 to May et al. claims the formation of BN from pyrolysis of a gas mixture of $(\text{MeO})_3\text{B}$ and NH_3 at a furnace temperature above about 850° C. The resulting product is a white powder containing B, N, O, C, and H in varying amounts depending upon reaction conditions. This powder is then heated in NH_3 atmosphere to 900–1100° C. to obtain BN. The '787 patent does not describe the morphology and crystallinity of the BN. However, it is likely that these processes produce BN with the traditional platelet morphology.

Further, in a series of patents, Bienert et al. describe the formation of boron-nitrogen-hydrogen compounds, $\text{BN}_{3-x}\text{H}_{6-3x}$, from the reaction of boron halides or boric acid esters with NH_3 in a heated gas flow tube held at 200° C. or 500° C. The resulting compounds are claimed to be useful for making detrition-resistant boron nitride pressed bodies, boron nitride powder and semiconduction components. (Bienert et al., Ger. Offen. No. 1,943,581; Ger. Offen. No. 1,943,582; Ger. Offen. No. 2,004,360; U.S. Pat. No. 3,711,594.) Finally, Murakawa et al. describe the use of $(\text{EtO})_3\text{B}$ in a hot gas stream of air and methane to form B_2O_3 and C. A powder compact was subsequently heated at 900° C. in N_2 . It was claimed that h-BN with spherical morphology (ave. diameter, approximately 0.14 micron) formed. (Japanese Patent No. JP60,200,811 to Kokai et al.)

Following from these separate observations, Kroenke, et al. (Organoboron Routes to Boron Nitride), U.S. Provisional Application Ser. No. 60/286,275, (filed Apr. 24, 2001) and (Organoboron Route and Process for Preparation of Boron Nitride), U.S. patent application Ser. No. 10/131/301 (filed Apr. 23, 2002), have shown that liquid $(\text{RO})_3\text{B}$ reagents, with and without nonaqueous solvents, may be used to form boron containing aerosols which can be efficiently nitrided in an AAVRS process. The resulting powders have a spherical morphology and contain boron, nitrogen, oxygen, carbon and hydrogen (designated as $\text{BN}_x\text{O}_y\text{C}_z$) wherein the oxygen contents are much lower (1–30%) than observed in the aqueous aerosol process described in the Pruss, et al. '179 patent for forming BN_xO_y powders. Further, the oxygen contents of the powders decrease with increasing reactor temperature from approximately 800° C. to approximately 1700° C. as shown in part in FIG. 2. Further, the $\text{BN}_x\text{O}_y\text{C}_z$

powders with low oxygen contents are readily converted in the first stage reactor system or in a second stage nitridation to BN with oxygen contents of approximately <1% and carbon and hydrogen contents of approximately <0.5%. A further and very important benefit of this precursor system is that the rate of production of $\text{BN}_x\text{O}_y\text{C}_z$ powder is significantly higher (approximately greater than 30 times higher) than observed in the aqueous based boric acid process described in the Pruss, et al. '179 patent. Therefore, the process described in U.S. Provisional Application Ser. No. 60/286,275 offers significant benefits over the process described in U.S. Pat. No. 6,348,179.

Despite the promising performance of the trialkyl borate aerosol process, there still remains a need in the art for a process that provides spherical boron nitride powders with lower and/or controllable elemental impurity concentrations that employs boron precursor raw materials that are less expensive and preferably less air and moisture sensitive than the alkyl esters of boric acid, $(\text{RO})_3\text{B}$.

SUMMARY OF THE INVENTION

The present invention is a method for an aerosol assisted vapor phase synthesis (AAVS) process of boron nitride (BN) wherein boron precursors are nitrided in one or two heating steps, and wherein a boron oxide nitride carbide intermediary composition is formed in the first heating step and is further nitrided in the same or a second heating step to form resultant spheroidal boron nitride powders including spheroidal particles that are smooth, bladed, have protruding whiskers and/or form platelet particles, and are of turbostratic or hexagonal crystalline structure.

The present invention comprises a method of forming a boron-nitrogen-oxygen-carbon, $\text{BN}_x\text{O}_y\text{C}_z$, precursor for BN comprising: providing a boron precursor, an inert carrier gas, and a nitriding agent, wherein said precursor is dissolved in solution, comprising a solution selected from the group consisting of non-aqueous and partially aquted, thereby forming a boron precursor solution; aerosolizing the boron precursor solution; forming a combined gas stream by introducing the carrier gas into a chamber containing the aerosolized precursor; heating the combined gas stream in a heated furnace, introducing the nitriding agent into the furnace; and reacting the nitriding agent and aerosolized precursor to form a powder of a boron-nitrogen-oxygen-carbon-hydrogen composition.

In this method, in the step of forming a combined gas stream, the chamber may comprise the furnace. It may include the additional step of introducing the nitriding gas into the furnace separately but simultaneously with the combined gas stream. Further, it may comprise an additional second heating step, wherein the boron-nitrogen-oxygen-carbon-hydrogen composition is heated in the presence of at least one member of the group consisting of a nitriding agent, an inert gas, and a vacuum.

In this method, in the step of introducing the nitriding agent, the nitriding agent may comprise at least one member selected from the group consisting of NH_3 , N_2 , N_2/H_2 , alkylamines, hydrazine, cyanamide, dicyanamide, hydroxylamines, urea, and mixtures thereof. In the aerosolizing step, the boron precursor agent may comprise at least one member selected from the group consisting of H_3BO_3 , B_2O_3 , ammonium borates, other non-aqueous solvent soluble borates, and mixtures thereof. The ammonium borates may comprise a member selected from the group consisting of ammonium tetraborate, ammonium pentaborate, ammonium polyborates, and hydrates thereof. The non-aqueous solution may

comprise at least one member selected from the group of solvents consisting of simple alcohols, methanol, ethanol, propanol, isopropanol, ethylene glycol, ethers, ethylene glycol dimethyl ether, and mixtures thereof.

In this method, in the step of introducing the nitriding agent, the nitriding agent may comprise a gas. Further, it may comprise a liquid, wherein the liquid is aerosolized, and is introduced into the furnace by a carrier gas. In the nitriding agent injection step, the injection of the nitriding agent may have a predetermined flow rate.

A combined gas stream and the nitriding agent may be simultaneously introduced into the furnace. Alternately, the combined gas stream and the nitriding agent may be separately introduced into the furnace. Further, the combined gas may have a predetermined flow rate for introducing the combined gas into the heated furnace.

In the heating step, heating of the furnace may comprise the additional step of maintaining a temperature between approximately 600°C . and approximately 1800°C ., preferably between approximately 1000°C . and approximately 1800°C .

The method may comprise an additional collection step wherein the boron-nitrogen-oxygen-carbon-hydrogen powder is collected on a powder collection device which may comprise a filter.

The method may comprise the additional steps of grinding the resultant $\text{BN}_x\text{O}_y\text{C}_z$ powder, spreading the powder over an oxide, and melting the powder over the oxide thereby reacting the powder with the oxide and NH_3 provided in a gas stream and forming a BN thin film layer. Alternately, it may comprise the additional steps of collecting the powder on a substrate; and melting the powder over the substrate in the presence of NH_3 , thereby forming a BN thin film layer.

In the method of the present invention, the resultant $\text{BN}_x\text{O}_y\text{C}_z$ powder may form an agglomerate.

The boron precursor solution may additionally comprise crystallization aids, and the crystallization aids may comprise at least one metal selected from the group consisting of s-, p-, and d-block elements. Further, they may comprise at least one metal salt selected from the group consisting of metal nitrates, metal acetates, and metal halides. Such a metal salt may comprise at least one salt selected from the group consisting lithium nitrates, lithium acetates, magnesium nitrates, magnesium acetates, copper nitrates, copper acetates, calcium nitrates, calcium acetates, metal chlorides, metal bromides, and metal iodides. Further, the boron precursor solution may additionally comprise nitride-forming metal dopants. These nitride-forming metal dopants may comprise at least one member selected from the group consisting of Al, Ga, In, Ti, Zr, Li, Mg, Ca, Mn, Sc, V, Cr, Fe, and Co.

The resultant $\text{BN}_x\text{O}_y\text{C}_z$ powder particles may comprise a morphology consisting of at least one member selected from the group of microporous, nanoporous, hollow, dense, high surface area, and low surface area. The $\text{BN}_x\text{O}_y\text{C}_z$ powder particles may agglomerate at the submicron level. Further, they may be intimately mixed with urea formed in situ.

The present invention further comprises a method for preparing h-BN comprising: providing a boron precursor, an inert carrier gas, and a nitriding agent, wherein said precursor is dissolved in solution, comprising a solution selected from the group consisting of non-aqueous and partially aquted, thereby forming a boron precursor solution; aerosolizing the boron precursor solution; forming a combined gas stream by introducing the carrier gas into a chamber containing the aerosolized precursor; heating the combined gas stream in a heated furnace; introducing the nitriding

agent into the furnace; reacting the nitriding agent and aerosolized precursor to form a powder of a boron-nitrogen-oxygen-carbon-hydrogen composition; and forming a boron-nitrogen powder by allowing the nitriding agent and the boron-nitrogen-oxygen-carbon-hydrogen composition to react with the nitriding agent in a second heating step.

In this method for preparing h-BN, the nitriding agent may comprise a member selected from the group consisting of NH_3 , N_2/H_2 , N_2 , alkylamines, hydrazine, cyanamide, dicyanamide, hydroxylamine, urea, and mixtures thereof.

Further, in this method for preparing h-BN, the boron precursor agent may comprise a boron precursor selected from the group consisting of boric acid, boric oxide, ammonium borates, other non-aqueous solvent soluble borates, and mixtures thereof. These ammonium borates may comprise a member selected from the group consisting of ammonium tetraborate, ammonium pentaborate, ammonium polyborates, and hydrates thereof.

Additionally, the non-aqueous solution may comprise at least one member selected from the group of solvents consisting of simple alcohols, methanol, ethanol, propanol, isopropanol, ethylene glycol, ethers, ethylene glycol dimethyl ether, and mixtures thereof.

The resultant $\text{BN}_x\text{O}_y\text{C}_z$ powder particles may comprise a morphology consisting of at least one member selected from the group of microporous, nanoporous, hollow, dense, high surface area, and low surface area.

Further, in the step of introducing the nitriding agent, the nitriding agent may comprise a liquid, and wherein the liquid is aerosolized and is introduced into the furnace by a carrier gas.

The aerosolized precursor, the carrier gas, and the nitriding agent may be simultaneously introduced into the furnace. The flow of the combined gas stream may have a predetermined flow rate. In the step of introducing the nitriding agent, the nitriding agent may have a predetermined flow rate.

In the step of first heating the furnace comprises the additional step of maintaining a temperature of between approximately 600°C . and approximately 1800°C ., preferably between approximately 1200°C . and approximately 1800°C .

The method may further comprise an additional collecting step wherein the boron-nitrogen-oxygen-carbon-hydrogen powder is collected on a collection device, and the device may comprise a filter.

The method may comprise the following additional steps in the second heating step: placing the collected boron-nitrogen-oxygen-carbon-hydrogen powder in a second furnace; and subjecting the powder to the second heating step in the second furnace.

The boron nitride powder may be collected on a collection device, and the device may be a filter.

The method may comprise the additional steps of venting a gas stream entrained with the boron-nitrogen-oxygen-carbon-hydrogen powder into a second furnace before the second heating step. Both heating steps may be performed in one furnace. If one furnace is used, it may be a vertical furnace.

The second heating step may comprises maintaining the temperature between approximately 600°C . and approximately 1800°C ., preferably between approximately 1200°C . and approximately 1800°C .

Modified h-BN particles may form morphological characteristics comprising configurations selected from the group consisting of turbostratic structures, bladed spherical particles, platelet particles, and particles having crystalline

whisker growth. These morphological characteristics may be determined by varying at least one condition selected from the group consisting of varying the aerosol conditions and varying the reactor conditions. Formed BN particles may comprise a diameter range between approximately 0.05 microns and approximately 100 microns. Resultant $\text{BN}_x\text{O}_y\text{C}_z$ powder particles may be intimately mixed with urea formed in situ.

BRIEF DESCRIPTION OF THE DRAWINGS

The accompanying drawings, which are incorporated into and form a part of the specification, illustrate one or more embodiments of the present invention and, together with the description, serve to explain the principles of the invention. The drawings are only for the purpose of illustrating one or more preferred embodiments of the invention and are not to be construed as limiting the invention. In the drawings:

FIG. 1 is a line graph depicting BN_xO_y powder oxygen concentration (wt. %) versus AAVS process temperature from $\text{H}_3\text{BO}_3/\text{NH}_3$ aerosol reaction as practiced in the '179 patent.

FIG. 2 is a line graph depicting $\text{BN}_x\text{O}_y\text{C}_z$ powder oxygen concentration (wt. %) versus AAVS process temperature from $(\text{MeO})_3\text{B}/\text{NH}_3$ aerosol reaction as practiced in U.S. Application Ser. No. 60/286,275.

FIG. 3 is a schematic drawing of an aerosol assisted vapor phase synthesis (AAVS) reactor system in accordance with the present invention; and

FIG. 4 is a schematic drawing of a typical single transducer reagent container (glass chamber);

FIG. 5 is a scanning electron micrograph (SEM) of $\text{BN}_x\text{O}_y\text{C}_z$ powder prepared from $\text{B}_2\text{O}_3/\text{MeOH}$ (ratio of approximately 1:12), at 1000°C . ($\text{N}_2=0.5\text{ L/min}$; $\text{NH}_3=3.5\text{ L/min}$);

FIG. 6 is a scanning electron micrograph (SEM) of $\text{BN}_x\text{O}_y\text{C}_z$ powder obtained from $\text{H}_3\text{BO}_3/\text{MeOH}$ (ratio of approximately 1:8), at 1000°C . ($\text{N}_2=0.5\text{ L/min}$; $\text{NH}_3=3.5\text{ L/min}$);

FIG. 7 is a scanning electron micrograph (SEM) of $\text{BN}_x\text{O}_y\text{C}_z$ powder prepared from $\text{B}_2\text{O}_3/\text{MeOH}$ (ratio of approximately 1:12), at 1400°C . ($\text{N}_2=0.5\text{ L/min}$, $\text{NH}_3=3.5\text{ L/min}$);

FIG. 8 is a scanning electron micrograph (SEM) of $\text{BN}_x\text{O}_y\text{C}_z$ powder prepared from $\text{H}_3\text{BO}_3/\text{MeOH}$ (ratio of approximately 1:8), at 1400°C . ($\text{N}_2=0.5\text{ L/min}$; $\text{NH}_3=3.5\text{ L/min}$);

FIG. 9 is a scanning electron micrograph (SEM) of $\text{BN}_x\text{O}_y\text{C}_z$ powder prepared from $\text{NH}_4\text{B}_5\text{O}_8\cdot 4\text{H}_2\text{O}/\text{MeOH}$ (in a concentration of approximately 0.5M), at 1200°C . ($\text{N}_2=0.5\text{ L/min}$, $\text{NH}_3=3.5\text{ L/min}$);

FIG. 10 is a scanning electron micrograph (SEM) of $\text{BN}_x\text{O}_y\text{C}_z$ powder prepared from $\text{NH}_4\text{B}_5\text{O}_8\cdot 4\text{H}_2\text{O}/\text{MeOH}$ (in a concentration of approximately 0.5M), at 1500°C . ($\text{N}_2=0.5\text{ L/min}$; $\text{NH}_3=3.5\text{ L/min}$);

FIG. 11 is a scanning electron micrograph (SEM) of BN powder obtained from $\text{BN}_x\text{O}_y\text{C}_z$ powder prepared from $\text{B}_2\text{O}_3/\text{MeOH}$ (ratio of approximately 1:12) at 1000°C . ($\text{N}_2=0.5\text{ L/min}$; $\text{NH}_3=3.5\text{ L/min}$) and calcined at 1600°C . ($\text{NH}_3=0.2\text{ L/min}$).

FIG. 12 is a scanning electron micrograph (SEM) of BN powder obtained from $\text{BN}_x\text{O}_y\text{C}_z$ powder prepared from $\text{B}_2\text{O}_3/\text{MeOH}$ (ratio of approximately 1:12) at 1400°C . ($\text{N}_2=0.5\text{ L/min}$; $\text{NH}_3=3.5\text{ L/min}$) and calcined at 1600°C . ($\text{NH}_3=0.2\text{ L/min}$).

DESCRIPTION OF THE PREFERRED EMBODIMENTS (BEST MODES FOR CARRYING OUT THE INVENTION)

The present invention is a method for an aerosol assisted vapor phase synthesis (AAVS) process of boron nitride (BN) wherein boron precursors are nitrified in one or two heating steps, and wherein a boron oxide nitride carbide intermediary composition is formed in the first heating step and is further nitrified in the same or a second heating step to form resultant spheroidal boron nitride powders including spheroidal particles that are smooth, bladed, have protruding whiskers and/or form platelet particles, and are of turbostratic or hexagonal crystalline structure.

Although use of trialkylborates in an AAVS process to form spherical morphology BN powders shows considerable commercial and laboratory promise, trialkylborates are somewhat moisture sensitive and the precursors are currently more expensive than the commonly employed precursors, H_3BO_3 and B_2O_3 , used to make the standard, commercial platelet morphology BN powders. A more cost-effective raw material for the AAVS process described herein provides not only the same range of materials described in U.S. Provisional Application No. 60/286,275 (incorporated herein by reference and filed by several of the same inventors of the present invention and commonly owned by the same assignee), but also an additional range of materials. This more cost-effective raw material for the AAVS process uses solutions containing, preferably, H_3BO_3 , B_2O_3 , ammonium borates and polyborates, or mixtures thereof, dissolved in non-aqueous solvents such as but not limited to alcohols (for example methanol (MeOH)) or partially aquated solvents or solutions, to form an aerosol mist wherein the aerosol droplets produced contain boron species in high concentrations.

The boron-containing raw material of the present invention may be chosen from the group of commercially available materials including but not limited to boric acid, H_3BO_3 , boric oxide, B_2O_3 , ammonium borates and polyborates. These are dissolved in a non-aqueous solvent or solvent mixture, including but not limited to alcohols. Preferably, the non-aqueous solvent comprises simple alcohols, including but not limited to, methanol and ethanol, or a combinations thereof. However, in some cases, the solvent may be partially aquated. In such cases, the range of water concentration is preferably less than or equal to 50 wt. % of water, most preferably, the range is less than or equal to 10 wt. % of water. In other cases, the boron precursor may be a hydrate, such that the resultant solution maintains the preferred concentration of water which is preferably less than or equal to 50 wt. % of water, most preferably, the range is less than or equal to 10 wt. % of water. The solution is transferred to an aerosol generator system such as the one depicted in FIGS. 3 and 4, utilizing bench or commercial scale models. The ideal preferred molar ratios of boron reagent to, for example, MeOH, is approximately 1:6 to approximately 1:40, and the most preferred ratio is approximately 1:6 to approximately 1:20.

These high concentration boron aerosols are introduced (e.g., injected) in a carrier gas stream (preferably comprised of nitrogen, argon, other inert gases known in the art, or combinations thereof) and are further introduced (e.g., swept) into a reaction zone of an aerosol assisted vapor phase reactor system (AAVRS) as better described below. The aerosols are then reacted there or are allowed to react with NH_3 , an NH_3 /inert gas mixture, or other appropriate nitrifying gases or gas mixtures, converting the aerosol to

$BN_xO_yC_z$ or BN particles depending upon the reactor temperature, gas flow rates, NH_3 or other nitrifying agent concentration and aerosol residence time. These primary $BN_xO_yC_z$ or BN particles may be unagglomerated, loosely agglomerated or tightly agglomerated depending upon synthesis conditions. Where required, the isolated powders can be further calcined in NH_3 , NH_3/N_2 , N_2 , or other suitable nitrifying agents, to form primary crystalline BN particles with oxygen contents of approximately <1% and carbon contents of approximately <0.5%.

The $BN_xO_yC_z$ or BN primary particles have spherical morphology in the micron- to nano-dimension range and may have smooth, bladed, partially bladed, partially textured, fibrils, or whisker surface nano-structures, or platelet or nanoplatelet shapes. The calcined BN particles may have a similar range of unagglomerated, loosely agglomerated, or tightly agglomerated or partially sintered configurations, depending upon calcining conditions and type of aerosol precursor. They may also be dense, hollow or porous.

$BN_xO_yC_z$ powders may further contain carbon, which can be removed, leaving a "tailored porosity and morphology" in the primary particles of BN. The non-aqueous or partially aquated solutions used to form the aerosol may also contain non-aqueous or aqueous solvent soluble additives that affect the aerosol conversion process, leading to a greater selectivity in final powder properties and/or morphology and/or crystallinity.

The system of the present invention, when operated in preferred ranges, typically produces negligible gaseous by-products (mainly CO , CO_2 and H_2) formed in the decomposition of non-aqueous solvent such as MeOH in NH_3 , and additionally, for example, in the reactions of H_3BO_3 , B_2O_3 , and borates with ammonia and non-aqueous solvent or their decomposition products.

When the reactor is run in the lowest preferred temperature range, urea may also be produced in situ with the $BN_xO_yC_z$ powder, from which the urea is easily removable if necessary or desired. The urea is intimately mixed with the $BN_xO_yC_z$ powder. Excess NH_3 and inert carrier gas dilute any gaseous or aerosolized by-products which are then swept from the system.

Overall production yields of ceramic powders are high (typically, approximately 70–90% in the bench scale laboratory reactor described herein, however, other yield ranges may be possible), and the simple process design and low operational costs are favorable for commercial applications. The powder formation rates of the non-aqueous routes of the present invention (typically, approximately 0.05 g/min.) are approximately five times those found in the aqueous H_3BO_3 process.

PROCESS ADVANTAGES

Compared to the process that utilizes trialkylborates as precursors, which already realizes a large advance over current commercial technology, the current invention provides the following additional advantages in process:

1. Use of readily available, less expensive boron-containing starting materials.
2. Use of non-aqueous solutions such as alcohol solutions of less expensive starting materials that are much less air and moisture-sensitive than neat $(RO)_3B$ liquids.
3. An aerosol containing controllable amounts of carbon that improves the parallel carbothermal reduction/conversion of B—O species into boron nitride, h-BN.
4. Ready and complete conversion of the boron precursors to BN powders.

5. Formation of spherically shaped powders containing controlled porosity and defined dopants/processing aides.

6. Option to prepare intimate mixtures of $\text{BN}_x\text{O}_y\text{C}_z$ with in situ formed urea (typically formed when reacting at 1000°C . or lower).

7. Option to manufacture partially sintered BN powder agglomerates after annealing $\text{BN}_x\text{O}_y\text{C}_z$ at approximately 1600°C . or higher without additional processing and/or use of additives.

8. Option to obtain modified surface structure features.

9. Option to produce BN material with densities in range of approximately 1.0 to approximately 2.2 g/cm^3 .

10. Option to produce BN nanocomposite materials.

The process of the present invention, forming a boron-nitrogen-oxygen-carbon-hydrogen intermediate composition ($\text{BN}_x\text{O}_y\text{C}_z$) and forming from such composition the desired spherically shaped or modified spherical morphology BN powder having either a turbostratic (t-BN) or a hexagonal (h-BN) crystal structure, as more particularly described herein, preferably includes the following steps: (1) introducing a boron reagent precursor dissolved in a preferably low molecular weight organic, non-aqueous solvent such as, but not limited to methanol, (2) creating an aerosol of the boron precursor reagent solution by using an aerosol droplets generated into a furnace, (4) injecting a gaseous nitriding agent (or a nitriding agent aerosol on a carrier gas) into the furnace, and (5) maintaining the temperature of the furnace within a temperature range of approximately 600°C . to approximately 1800°C . Additional steps of the method may be utilized, including (6) heat-treating the $\text{BN}_x\text{O}_y\text{C}_z$ precursor particles after step 5 (and possibly, including a another step (5b), collecting the resultant intermediate, $\text{BN}_x\text{O}_y\text{C}_z$ powder particles) at approximately 600°C . to approximately 1800°C . under nitriding conditions. Another possible collecting step, (7), would comprise collecting the fully nitrided particles. The process may be further modified by introducing non-aqueous solvent soluble additives in the solution of step (1) which allows for the formation of $\text{BN}_x\text{O}_y\text{C}_z$ powders containing additional elements that modify the composition, crystallinity, and/or properties of the resulting BN materials

The aerosol assisted vapor phase reactor system (AAVRS) apparatus for forming spherical BN as described above typically comprises an aerosol generator system (capable of producing an aerosol spray of droplets of the preferred non-aqueous boron precursor solution), a means for injecting the aerosol droplets composed of the boron precursor and non-aqueous solvent in an inert carrier gas into a heated reactor tube at a controlled flow rate, and a means for injecting a gaseous nitriding agent (or aerosol containing a liquid nitriding agent in an inert carrier gas) separately into the furnace (preferably substantially simultaneously to the injection of the reagent solution/carrier gas aerosol).

Turning now to the drawings, a schematic diagram of an aerosol assisted vapor phase reactor system (AAVRS) 10 used in accordance with the method of the present invention is shown in FIG. 3. The AAVRS 10 depicted is a "bench scale" system, but the methods of the present invention additionally apply to an apparatus on a commercial production scale AAVRS 10 comprises aerosol generator assembly 12, inert carrier gas source 14, nitriding source 16, connection systems 18, 18', 18'', 18''' furnace 20, wherein furnace 20 further preferably comprises furnace tube 40, and preferably, collection device 41.

Generator assembly 12 preferably comprises ultrasonic transducer assembly 21. Other generator assemblies may be

utilized, including but not limited to spray nozzles, nebulizers, and atomizers. It should be understood that many different aerosol generator geometries may be employed as the droplet generator. The selection of a particular aerosol or droplet generator and droplet delivery system or geometry will preferably depend upon the AAVRS type and size, target droplet size, droplet size distribution, droplet delivery rate and chemical composition of the droplet. For example, an impactor (e.g., barrier) may be inserted in-line in the delivery system to modify the particle size distribution and decrease the delivery rate. Different spray nozzle designs may be employed to vary the size of the droplets; different additives can be added to the boron reagent solution to modify the surface tension of the solution; and the solubility of the boron reagent may be varied by varying the temperature (i.e., solubility is increased with an increase in temperature) and/or the solvent utilized.

Transducer assembly 21 preferably comprises humidifier base 22, glass chamber 24, diaphragm 26, and ultrasonic transducer 28. Humidifier base 22 contains transducer 28 and may be a preformed commercial unit (e.g., Holmes Model 643B). Water or another suitable liquid fills base 22, contacting both diaphragm 26 and transducer 28.

Glass chamber 24 may comprise multiple configurations including, but not limited to the flask shape shown in FIG. 4. Glass chamber 24 comprises at least one outlet 25 in connected relation to connection system 18'. Connection system 18' is disposed between chamber 24 and furnace tube 40. Glass chamber 24 additionally comprises at least one inlet 38 in connected relation to connection system 18 and to a boron reagent solution storage vessel (not shown). Connection system 18 is disposed in connected relation between chamber 24 and inert gas source 14. Additional inlets such as inlets 38', 38'' depicted in FIG. 4, may also be utilized to connect additional inert gas sources or for sweeping a lower density of aerosol droplets into 18' Inlet 38 may be used for continuous or batch transfer of precursor solution 32 to chamber 24. Accordingly, multiple lines of connection system 18 may be utilized when multiple inlets or outlets are used.

Diaphragm 26 is preferably comprised of a thin, flexible material such as polyethylene, which has a suitable tension for transmitting ultrasonic energy from an emitter source 28 to liquid precursor solution 32 contained within glass chamber 24 (See FIGS. 3 and 4). Preferably, diaphragm 26 will also be comprised of a suitably inert material with respect to the utilized precursor solution. Other polymers and/or membranes may be suitable for the diaphragm material, provided they comprise a suitable tension and are chemically inert to the precursor. Additionally, a method known in the art of using a chamber comprised entirely of glass, wherein the "diaphragm area" is comprised of a very thin glass layer, may be employed. As a result, other such materials known in the art may be utilized for the diaphragm. Diaphragm 26 is stretched fittingly over bottom 34 of glass chamber 24, and may be attached with means known in the art, such as but not limited to, a fitted ring. Diaphragm 26 is preferably positioned in relation to transducer 28 for best sonic transmission, preferably with transducer 28 immediately proximate to diaphragm 26 and centrally positioned, but leaving a small gap as is commonly known in the art.

Ultrasonic transducer 28 is mounted in humidifier base 22 and preferably comprises a piezoelectric crystal, but may comprise other transducers known in the art. Transducer 28 is electrically stimulated, thereby creating ultrasonic stimulation of diaphragm 26. Diaphragm 26 transmits the ultrasonic energy to precursor solution 32, thereby creating an

13

aerosol of precursor solution 32 Other aerosol generator configurations known in the art may be utilized in performing the methods of the present invention. Additionally, multiple generators may be utilized. However, it is preferred that the amount of aerosol generated by such generators be proportioned to the size of the reactor furnace.

Inert carrier gas source 14 typically comprises a gas tank or chamber containing an inert gas or gas mixture, such as but not limited to N_2 and Ar. Other inert gases and mixtures thereof known in the art may also be utilized in the present invention. As shown in FIG. 3, inert carrier gas source 14 is connected to chamber 24 by connection system 18 comprising tubes, connected chambers, pipes, or other delivery mechanisms known in the art, and disposed between source 14 and chamber 24. The carrier gas is injected into aerosol chamber 24 (containing boron precursor solution 32) at inlet 38' or 38" as depicted in FIG. 4. If multiple chambers 24 and/or sources 14 are utilized, more inlets may be used. It is preferred that at least two inlets or one valved inlet (wherein precursor solutions and various inert gas flows may alternately be blocked or allowed passage past the valve, thereby alternating flow of precursor solution or inert gas into the chamber) be available and/or used to provide for a suitable flow of the carrier gas, accommodating differing aerosol densities within the aerosol chamber. Spacing between inlets need not be uniform, and may vary. Varied spacing may be useful for different inlet purposes. For example, on a multiple-inlet chamber (such as depicted in FIG. 4), bottom inlet 38 is typically used to batch transfer the precursor solution into the chamber. Upper inlets 38', 38" may be used for flow of carrier gas to mix with different density levels of aerosol (e.g., the lower the height of the aerosol within the chamber, the higher the density of the aerosol). The carrier gas serves to transport aerosol droplets of precursor solution 32 into furnace 20, by carrying the aerosol droplets through connection system 18', disposed between chamber 24 and furnace tube 40. Preferably, the flow rate of the carrier gas through connection system 18' corresponds to the flow rate of the carrier gas through connection system 18.

Nitriding gas source 16 typically comprises a gas tank or chamber containing a nitrogen-containing gas or gas mixture known in the art, preferably NH_3 . The nitrogen-containing gas mixture may comprise a liquid or solution suitable for nitriding that is aerosolized and therefore utilizes an inert carrier gas for flow into the furnace. Nitriding gas source 16 is connected to furnace tube 40 by connection system 18". In alternate embodiments, connection system 18", as depicted in FIG. 3, additionally flows from inert carrier gas source 14 to furnace 20, for direct flow of the inert gas into furnace tube 40. While this is not critical to the AAVS process described herein, it is helpful in the process, for example, in maintaining a gas flow pressure to "push" the remaining aerosol entrained in the reactor and connecting tubes through into the furnace after the aerosol generator has been turned off.

Connection systems 18', 18", 18" join to a gas tight end cap disposed in the proximate end of furnace tube 40 of furnace 20. The carrier gas, carrying the aerosol droplets, flows through connection system 18' into tube 40. Preferably, at essentially the same time, the nitriding gas is separately injected into furnace tube 40 through connection system 18" at a flow rate preferably approximately proportional to the flow rate of carrier gas. In alternate embodiments, different flow rates may be utilized. The flow rate may comprise a flow proportion of between approximately 5:1 of $N_2:NH_3$ to approximately 1:20 of $N_2:NH_3$. It is preferred, however, that the flow rate comprise a flow

14

proportion of between approximately 1:1 of $N_2:NH_3$ to approximately 1:10 of $N_2:NH_3$. The nitriding gas mixes inside reactor tube 40 with the aerosol droplets of boron precursor solution 32, leading to a series of reactions which form particles of $BN_xO_yC_z$, the boron nitride precursor intermediate structure as more completely described infra. The particles of $BN_xO_yC_z$ will preferably exhibit spherical shape provided the aerosol droplets are formed and the furnace is heated

All connection systems 18, 18', 18", 18" may comprise tubes, connected chambers, pipes, or other delivery mechanisms known in the art. Connection systems may additionally comprise valves for blocking and/or controlling the flow of the carrier gas, as well as check valves to prevent backward flow. Further, connection systems may comprise joints (e.g., elbow joints), connectors (e.g., T-connectors), and affixing means known to the art (e.g., threaded insertion ends, couplings, etc.), as well as multiple flow lines per each system (e.g., when multiple inlets or outlets are used on connected structures). Finally, the connection systems may additionally comprise mechanical or computerized gauge and check systems for monitoring and controlling the flow of gas manually or automatically which may be interconnected with any mechanical or computerized gauge and/or check systems for monitoring and controlling the furnace temperature, gas volume and pressure within the furnace tube.

Flow for both the nitriding gas source and the inert carrier gas source may comprise a wide range of flow rates that are generally at least somewhat dependent on the furnace type used. The furnace used may be a commercial or a bench scale model. An example of a bench scale model furnace that may be used is a Lindbergh Model 54779, fitted with a nominal 4" diameter x 6' length reactor tube. A preferred combination range for flow rates of the nitriding gas and carrier gas used for this particular bench scale model furnace, including flow rate, is approximately 0.2 L/min N_2 + approximately 0.2 L/min NH_3 to approximately 2 L/min N_2 + approximately 6 L/min NH_3 . Other flow rates may be used as discussed supra, especially on commercial scale model furnaces. The most preferred gas mixtures and proportions are ones with $N_2:NH_3$ ratios less than or equal to 1. Ratios of $N_2:NH_3$ greater than 1 typically result in reduced nitriding characteristics. Other less preferred reactants that may be utilized as a nitriding source include nitrogen, nitrogen/hydrogen mixtures, alkyl amines, hydrazine, cyanamide, and dicyanamide, hydroxylamine, urea, or mixtures thereof.

In the preferred method, furnace tube 40 will be heated to a temperature of between approximately 600° C. and approximately 1800° C., preferably between approximately 1200° C. and approximately 1800° C. This causes reactions between the boron containing aerosol droplets and the nitriding gas, forming the intermediate precursor product, $BN_xO_yC_z$, wherein x, y, z are less than or equal to 2.5.

The resultant product may also comprise hydrogen atoms, thereby forming a composition, $BN_xO_yC_zH_q$ (wherein q is greater than or equal to 0), however, for the purposes of this application, such a composition is considered to be within the references to the $BN_xO_yC_z$ composition, therefore all references in the description and claims to the $BN_xO_yC_z$ composition are understood to include $BN_xO_yC_zH_q$ compositions.

Depending upon the reaction conditions utilized in the synthesis, the $BN_xO_yC_z$ powder will have oxygen contents that preferably range from approximately 40 wt. % to approximately 0.5 wt. %, and carbon contents that prefer-

ably range from approximately 10 wt. % to approximately 0.2 wt. %. When the bench scale reactor is operated within the preferred variables and conditions, the powder oxygen contents preferably range from approximately 10 wt % to approximately 0.1 wt %, and the carbon contents preferably range from approximately 0.5 wt. % to approximately 0 wt. %

Scanning electron micrographs (SEM) showing examples of the typical spherical shape of $\text{BN}_x\text{O}_y\text{C}_z$ powders obtained by the methods of the present invention are depicted in FIGS. 5–10. These were obtained, respectively, from aerosol combinations of $\text{H}_3\text{BO}_3/\text{MeOH}$, $\text{B}_2\text{O}_3/\text{MeOH}$, and $\text{NH}_4\text{B}_5\text{O}_8 \cdot 4\text{H}_2\text{O}/\text{MeOH}$, and were heated at various temperatures from approximately 1000°C . to approximately 1500°C . The examples demonstrate that in this temperature range, oxygen contents vary as described above, with a lower percentage oxygen powder obtained with higher process temperatures (if no significant amount of water is present in the system). In order to avoid significant amounts of water, it is preferred that the original water content does not exceed approximately 50 wt. %. Most preferably, the original water content will not exceed approximately 10 wt %. It is understood that in both these ranges, that the original water content may vary between no measurable water content (0 wt. %) and the upper ranges listed above. Light agglomeration of the primary particles at the submicron level, giving micron-sized agglomerates of submicron primary particles is demonstrated. Fines may occur as a result of the process or SEM sample preparation. (See, FIGS. 5–10) However, it is not anticipated that the fines interfere with the preferred morphology of the resultant h-BN powders of the invention.

These spherical precursor particles of the present invention are carried by the inert carrier/nitriding gas stream through the furnace where the particles are captured on an impact filter, a bag filter assembly, or other known capturing device 41. The filter unit is opened and the powder is collected through conventional methods well known in the art.

In the event that the boron nitride powders, collected as described above, have higher levels of oxygen and carbon impurities than desired, the collected samples are preferably inserted into another furnace (not shown) for additional nitriding/calcining. This is preferably done in an ammonia-rich (or other nitriding agent rich) atmosphere at a furnace temperature of between 600°C . and 1800°C . to form dense BN particles of spherical shape with an B:N ratio of approximately 1:1, and having a hexagonal or turbostratic structure. When formed from H_3BO_3 and B_2O_3 (typically, at approximately 1000°C . to approximately 1400°C .), the calcined material tends to produce large macroscopic “blocks” of BN agglomerates or partially sintered BN agglomerates. When formed from H_3BO_3 or B_2O_3 (at above 1400°C .), loose, free-flowing BN is typically obtained. The $\text{BN}_x\text{O}_y\text{C}_z$ products formed from ammonium borates usually show little or no agglomeration at process temperatures from approximately 1000°C . to approximately 1700°C . Loose, free-flowing BN can also be obtained from all samples derived from ammonium borates (regardless of temperature).

As discussed above, the temperature of the furnace in the AAVS (during the first heating step, stage 1) affects the $\text{BN}_x\text{O}_y\text{C}_z$ powder O and C contents. For example, temperatures below 600°C . produce high O and C contents and irregular particle morphology. At 600°C ., spherical powders with O content of, for example, approximately 40 wt. % and C content of approximately 1% are typically produced. The oxygen content then dramatically decreases with increasing

reactor tube temperature above 600°C . When the reactor atmosphere is richer in NH_3 , the oxygen content of the $\text{BN}_x\text{O}_y\text{C}_z$ powder also decreases with increasing reactor tube temperature despite the concomitant shorter aerosol residence times. This behavior is closely related to the observations described in U.S. Patent Application No. 60/286,275, previously incorporated herein by reference.

The flow rate of the gases can also be varied with flow controllers 44, as depicted in FIG. 3, to alter the residence time of the particles in the furnace and/or to change the mole fraction of the primary nitriding gas, NH_3 , relative to the carrier gas, N_2 . The flow rates can be either increased or decreased depending on the residence time desired. For example, using $\text{B}_2\text{O}_3/\text{MeOH}$ solutions, when the reactor tube temperature is held at 1400°C . and total gas flow rate is set at 4L/min, as the NH_3 mole fraction increases, the weight percent oxygen of the resulting $\text{BN}_x\text{O}_y\text{C}_z$ drops off dramatically from approximately 25% to less than approximately 10%. Similar trends appear with other reactor temperatures. Therefore, a ratio of $\text{N}_2:\text{NH}_3$ less than or equal to 1 is preferred. However, in alternate embodiments, ratios greater than 1 may be utilized in order to make a $\text{BN}_x\text{O}_y\text{C}_z$ having higher oxygen and carbon contents, when desired.

The need for the use of a “second” heating step to further nitride the $\text{BN}_x\text{O}_y\text{C}_z$ powder when a “purer” BN end product is desired is shown by $\text{BN}_x\text{O}_y\text{C}_z$ powder characterization using bulk elemental analysis, X-ray diffraction (XRD) and scanning electron microscopy (SEM). These data confirm that the Stage 1 (after the first heating step) AAVS runs produce spherical morphology $\text{BN}_x\text{O}_y\text{C}_z$ powders that have a low degree of crystalline order or are turbostratic.

The time and temperature of additional nitridation/calcination and post-nitriding determine the residual oxygen and carbon contents and, consequently, the final degree of crystallinity of the BN product. However, it has been further discovered in accordance with the present invention that the nitridation/calcination time and temperature are inversely proportional. Accordingly, the heat treatment time may be shortened by proportionally raising the nitridation/calcination temperature. The heat treatment step may or may not change the spherical morphology of the BN particles, depending on the nitridation/calcination conditions. It is also possible to skip the collection of intermediate $\text{BN}_x\text{O}_y\text{C}_z$ powder and feed the initially produced gas stream containing $\text{BN}_x\text{O}_y\text{C}_z$ powder into a second, separately heated reactor where final nitridation takes place. Finally, it is also possible to use a vertical furnace configuration (with or without counter current gas/aerosol flow) or other modified reactor designs thereby extending the aerosol residence time in the reactor so that spherical morphology or related morphologies are obtained in a single stage, with low oxygen and carbon contents, without second stage calcination, to give hexagonal or turbostratic BN. It is possible to perform such a “one-step” reaction in a horizontal furnace as depicted in FIG. 3, however, it is anticipated that the yield will render greater impurities, wherein “impurities” are viewed as BN structures not having a spheroidal structure or additional elements other than boron or nitrogen.

Therefore, in order to remove the remaining O and C impurities and increase the powder crystallinity, the $\text{BN}_x\text{O}_y\text{C}_z$ powders are preferably nitrided further under NH_3 , as shown in the following generalized reaction:

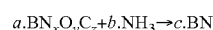

where a, b, and c are >0 ; x, y, and z are ≥ 0 ; and additional volatile products, for example CO_2 and CO, may result.

17

In the preferred method, the $\text{BN}_x\text{O}_y\text{C}_z$ powders are collected from the tube furnace and placed in a second furnace (or the powder is not collected and the powder entrained on a gas stream is simply vented to the second furnace), or are subjected to an additional run in the original furnace. (See Example 1, *infra*.) Additional carbon can be added to assist with the O replacement via carbothermal reduction, if desired. This carbon addition may be accomplished, for example, by use of higher molecular weight R groups for the non-aqueous, preferably alcohol compounds in the precursor solvent, thereby increasing the relative proportion of the non-aqueous solvent in the solution by addition of alkane, amine, or arene compounds in the aerosol feed stream, or by addition of carbon powder to the $\text{BN}_x\text{O}_y\text{C}_z$ powder.

The nitriding conditions of this method may be varied in order to obtain particles that have morphologies that include but are not limited to smooth spherical particles that have a turbostratic structure, "textured" or bladed surface roughened spherical particles, "fuzzy" spherical particles having crystalline whisker growth on the primary particle surfaces, "bladed" spherical morphology particles where the blades are highly ordered h-BN or fully platelet morphology particles that have the h-BN crystal structure. Variations in aerosol precursor, aerosol generation, aerosol processing, and reactor conditions (Stage I) and subsequent powder nitridation (Stage II) allow for the formation of alternative products in addition to the dense spherical particles described above. For example, $\text{BN}_x\text{O}_y\text{C}_z$ powders produced at lower temperatures and/or with lower relative amounts of nitriding gas, NH_3 , and/or lower residence times have higher concentrations of oxygen (e.g., approximately 20% to approximately 35%).

Additionally, the nitridation conditions may also be varied in order to affect final powder density, surface area and microporosity. The amount of carbon in the $\text{BN}_x\text{O}_y\text{C}_z$ can be conveniently varied by use of higher molecular weight R groups for the non-aqueous, preferably alcohol compounds in the precursor solvent, thereby increasing the relative proportion of the non-aqueous solvent in the solution by addition of alkane, amine, or arene compounds in the aerosol feed stream, as well by nitridation conditions in Stage I. The resulting nano-dispersed carbon can be involved in both carbothermal reduction/nitridation stage reactions with ammonia (Stage II) providing microporous or nanoporous powder particles with variable surface areas (e.g., 20–500 m^2/g) and porosities, including hollow and dense particles.

Further, the addition of s-, p-, and d-block elements are known to affect the crystallization of BN. In this process, metals (designated as M, wherein $a \geq 0.001$) in the form of soluble salts such as nitrates and acetates are added to the non-aqueous solvent and subsequent aerosol processing gives $\text{BN}_x\text{O}_y\text{C}_z\text{M}_a$ powders. This includes, but is not limited to Li, Mg, Ca, and Cu salts. Additionally, metal halides, such as but not limited to those formed with Cl, Br, and I may be used. Subsequent calcining under a nitriding atmosphere promotes growth of platelets and fibrils and whiskers on the primary BN particle surfaces.

Nitride forming metals also may be added as soluble salts to the aerosol forming solution and subsequent processing gives $\text{BN}_x\text{O}_y\text{C}_z\text{M}'_b$ compositions (wherein M' designates a metal, and $b \geq 0.001$). This includes, but is not limited to Al, Ga, Ti, Zr, Li, Mg, Ca, Mn, Sc, V, Cr, Fe, and Co. Subsequent calcining under nitriding atmospheres gives composite nitrides $\text{BN}/(\text{M}'_c\text{N})_d$ wherein M' designates a metal, and wherein preferably, $c \geq 0.05$ and more preferably $c \leq 3.0$, and wherein preferably $d \geq 0.001$.

18

The following examples describe application of the preferred methods of the present invention and these are given for illustration purposes only. None of the parameters of the examples used are intended to further limit the specifications or claims in any fashion.

EXAMPLE 1

Boric acid (H_3BO_3) (30.92 g, 0.5 mol) was mixed with methanol (CH_3OH) (162 ml, 4.0 mol). The mixture was stirred for several hours until clear (the MeOH solution can be warmed to accelerate dissolution, if necessary). The solution was transferred to a storage container attached to an aerosol generation vessel such as shown in FIG. 4, and was then added (in batches) to the aerosol generation vessel to provide continuous aerosol mist after activation of the aerosol transducer (some amount of methyl ester may form in this process). Approximately 20–25 mL of $\text{H}_3\text{BO}_3/\text{MeOH}$ solution was converted to aerosol mist per hour under these conditions. Mist was swept into the AAVRS tube by a stream of nitrogen gas (0.5 L/min) where it was mixed with NH_3 vapor (3.5 L/min), added separately. The resulting aerosol vapor stream (liquid volume of ~20–25 mL/hr) was carried through the reactor in the N_2/NH_3 gas mixture. The reactor temperature was held at 1000° C. The resulting $\text{BN}_x\text{O}_y\text{C}_z$ powder was collected on an impact filter at the distal end of the reactor, comprising a yield of 4.9 g of off-white powder in 4 hours. Chemical analysis was C=9.9%; H=4.7%; N=39.3%; O=21.9%; B=17.2%. Subsequent heating of this material at 1600° C. (4 h) under NH_3 (0.2 L/min) gave a white powder having a chemical analysis of C=1.0%; H=0.6%, N=53.4%; O=1.4%; B=42.8%, and a BN ceramic yield of 80% in the second pyrolysis step.

EXAMPLE 2

$\text{BN}_x\text{O}_y\text{C}_z$ powder was prepared as described in Example 1 with the exception that the reactor temperature was set at 1400° C. Off-white powder (2.5 g) was collected on an impact filter with a chemical analysis of C=2.5%; H=1.3%; N=37.2%; O=21.5%; B=36.8%. Subsequent heating of this material at 1600° C. (4 h) under NH_3 (0.2 L/min) gave a white powder having a chemical analysis of C=0.4%, H=0.2%; N=52.9%; O=1.6%, B=42.7%. The ceramic yield of BN was 80% in the second pyrolysis step.

EXAMPLE 3

Crystalline boric oxide (B_2O_3) (34.81 g, 0.5 mol) was placed in a 250 mL flask with a stir bar and fitted with a septum-covered side arm, a reflux condenser, and a nitrogen gas purge inlet. Methanol (CH_3OH) (162 mL, 4.0 mol) was slowly added in small portions from an air tight syringe connected to the flask through the side arm septum. An exothermic reaction resulted. The CH_3OH addition was varied to evenly control the solution reflux. The mixture was stirred vigorously throughout the addition in order to avoid clumping of the B_2O_3 reagent. This solution ($\text{B}_2\text{O}_3/\text{CH}_3\text{OH}$ ratio of 1:8) was close to the saturation limit of the solution, so a small amount of extra CH_3OH may need to be added to insure that no solid reforms during the aerosol mist generation. The solution was transferred to a storage container attached to the aerosol generation vessel such as shown in FIG. 4 and added (in batches) to the aerosol generation vessel to provide continuous aerosol mist generation after activation of the transducer (methyl ester may form). Mist was swept into the AAVRS tube by a stream of nitrogen gas

19

(0.5 L/min) where it was mixed with ammonia (NH₃, 3.5 L/min), added separately. The aerosol vapor (liquid volume of approximately 20–25 mL/h) was carried through the reactor in the N₂/NH₃ gas mixture with the reactor temperature set at 1400° C. The resulting BN_xO_yC_z powder was collected on an impact filter at the distal end of the reactor, yielding 0.8 g of off-white powder in 1 hour, and having a chemical analysis showing an oxygen content of 10.3%. Subsequent heating at 1600° C. (4 h) under NH₃ (0.2 L/min) gave a white powder with an oxygen content of 0.8%, and a BN ceramic yield of 79%.

EXAMPLE 4

BN_xO_yC_z powder was prepared as described in Example 3 except using a solution containing B₂O₃ (24.37 g, 0.35 mol) and CH₃OH ratio of 1:12 and a reactor tube temperature of 1000° C. About 130–140 mL of solution was used. The resulting BN_xO_yC_z powder (7.5 g collected in 4 h) was light gray and displayed a chemical analysis C=9.8%; H=4.1%; N=40.0%; O=19.8%; B=18.5%. Subsequent heating at 1600° C. (4 h) under NH₃ (0.2 L/min) gave a white powder with an analysis of C<0.2%; H<0.2%; N=56.4%; O=1.3%; B=43.4%, and a BN ceramic yield of 80%.

EXAMPLE 5

BN_xO_yC_z powder was prepared as described in Example 4 except using a reactor temperature of 1400° C. About 100–120 mL of solution was used. The resulting BN_xO_yC_z powder (5.1 g collected in 4 h) was off-white and displayed a chemical analysis of C=0.5%; H=0.5%; N=44.8%; O=12.4%; B=40.0%. Subsequent heating at 1600° C. (4 h) under NH₃ (0.2 L/min) gave a white powder with a chemical analysis of C<0.1%; H=0.2%; N=54.2%; O=1.0%; B=44.2%, and a BN ceramic yield of 71%.

EXAMPLE 6

Crystalline ammonium pentaborate tetrahydrate NH₄B₅O₈·4H₂O (20.00 g or 0.073 mol), was dissolved in 150 mL of methanol affording an approximately 0.5M solution. The solution was transferred to a storage container attached to the aerosol generation vessel such as shown in FIG. 4 and added (in batches, about 140 mL of the solution was used) to the aerosol generation vessel to provide continuous aerosol mist generation after activation of the transducer. Mist was swept into the AAVRS tube by a stream of nitrogen gas (1.0 L/min) where it was mixed with ammonia (3.0 L/min), added separately. The aerosol medium was carried through the reactor in the N₂/NH₃ gas mixture with the reactor temperature set at 1400° C. The resulting BN_xO_yC_z powder was collected on an impact filter at the distal end of the reactor, yielding 2.22 g of a very light gray powder after 3 hours. The powder displayed a oxygen content of 24.8%. Subsequent heating of the sample at 1600° C. (for 4 hours) under nitriding conditions (NH₃ at 0.2 L/min) yielded a white powder with an oxygen content of 1.4% and a BN ceramic yield of 78%.

EXAMPLE 7

BN_xO_yC_z powder was prepared as described in Example 6, except a reactor temperature of 1500° C. was used. The resulting BN_xO_yC_z powder was a very light gray and had an oxygen content of 29.0%. The powder was collected after 3 hours, yielding 2.46 g. Subsequent heating of the sample at

20

1600° C. (for 4 hours) under nitriding conditions (NH₃ at 0.2 L/min) yielded a white powder with an oxygen content of 2.1% and a BN ceramic yield of 77%.

Although the invention has been described in detail with particular reference to these preferred embodiments, other embodiments can achieve the same results. Variations and modifications of the present invention will be obvious to those skilled in the art and it is intended to cover in the appended claims all such modifications and equivalents. The entire disclosures of all references, applications, patents, and publications cited above are hereby incorporated by reference.

What is claimed is:

1. A method of forming a boron-nitrogen-oxygen-carbon-hydrogen, BN_xO_yC_z, precursor for BN comprising:

providing a boron precursor, an inert carrier gas, and a nitriding agent, wherein said precursor is dissolved in solution, having a solvent selected from the group consisting of non-aqueous solvent and partially aquated solvent, thereby forming a boron precursor solution, wherein partially aquated boron precursor solutions contain less than or equal to 50 wt. % water;

aerosolizing the boron precursor solution;

forming a combined gas stream by introducing the carrier gas into a chamber containing the aerosolized precursor;

heating the combined gas stream in a heated furnace;

introducing the nitriding agent into the furnace; and

reacting the nitriding agent and aerosolized precursor solution to react to form a powder of a boron-nitrogen-oxygen-carbon composition.

2. The method of claim 1 wherein in the step of forming a combined gas stream, the chamber comprises the furnace.

3. The method of claim 1 comprising the additional step of introducing the nitriding gas into the furnace separately but simultaneously with the combined gas stream.

4. The method of claim 1 comprising an additional second heating step, wherein the boron-nitrogen-oxygen-carbon-hydrogen composition is heated in the presence of at least one member of the group consisting of a nitriding agent, an inert gas, and a vacuum.

5. The method of claim 1 wherein in the step of introducing the nitriding agent, the nitriding agent comprises at least one member selected from the group consisting of NH₃, N₂, N₂, N₂/H₂, alkylamines, hydrazine, cyanamide, dicyanamide, hydroxylamines, urea, and mixtures thereof.

6. The method of claim 1 wherein in the aerosolizing step, the boron precursor agent comprises at least one member selected from the group consisting of H₃BO₃, B₂O₃, ammonium borates, other non-aqueous solvent soluble borates, and mixtures thereof.

7. The method of claim 6 wherein the ammonium borates comprise a member selected from the group consisting of ammonium tetraborate, ammonium pentaborate, ammonium polyborates, and hydrates thereof.

8. The method of claim 1 wherein the non-aqueous solution comprises at least one member selected from the group of solvents consisting of alcohols, ethers, and mixtures thereof.

9. The method of claim 1, wherein in the step of introducing the nitriding agent, the nitriding agent comprises a gas.

10. The method of claim 1 wherein the nitriding agent comprises a liquid, and wherein the liquid is aerosolized and is introduced into the furnace by a carrier gas.

21

11. The method of claim 1 wherein the combined gas stream and the nitriding agent are simultaneously introduced into the furnace.

12. The method of claim 1 wherein the combined gas stream and the nitriding agent are separately introduced into the furnace.

13. The method of claim 1 wherein the combined gas has a predetermined flow rate for introducing the combined gas into the heated furnace.

14. The method of claim 1 wherein in the nitriding agent injection step, the injection of the nitriding agent has a predetermined flow rate.

15. The method of claim 1 wherein in the heating step, heating of the furnace comprises the additional step of maintaining a temperature between approximately 600° C. and approximately 1800° C.

16. The method of claim 15 wherein the temperature is maintained between approximately 1000° C. and approximately 1800° C.

17. The method of claim 1 comprising an additional collection step wherein the boron-nitrogen-oxygen-carbon-hydrogen powder is collected on a powder collection device.

18. The method of claim 17 wherein in the collection step the boron-nitrogen-oxygen-carbon-hydrogen powder is collected on a filter.

19. The method of claim 1 comprising the additional steps of grinding the resultant $\text{BN}_x\text{O}_y\text{C}_z$ powder, spreading the powder over an oxide, and melting the powder over the oxide thereby reacting the powder with the oxide and NH_3 provided in a gas stream and forming a BN thin film layer.

20. The method of claim 1 comprising the following additional steps:

collecting the powder on a substrate; and

melting the powder over the substrate in the presence of NH_3 , thereby forming a BN thin film layer.

21. The method of claim 1, wherein the resultant $\text{BN}_x\text{O}_y\text{C}_z$ powder forms an agglomerate.

22. The method of claim 1, wherein boron precursor solution additionally comprises crystallization aids.

23. The method of claim 22, wherein the crystallization aids comprise at least one metal selected from the group consisting of s-, p-, and d-block elements.

24. The method of claim 22, wherein the crystallization aids comprise at least one metal salt selected from the group consisting of metal nitrates, metal acetates, and metal halides.

25. The method of claim 24, wherein the metal salt comprises at least one salt selected from the group consisting of lithium nitrates, lithium acetates, magnesium nitrates, magnesium acetates, copper nitrates, copper acetates, calcium nitrates, calcium acetates, metal chlorides, metal bromides, and metal iodides.

26. The method of claim 1 wherein the boron precursor solution additionally comprises nitride-forming metal dopants.

27. The method of claim 26 wherein the nitride-forming metal dopants comprise at least one member selected from the group consisting of Al, Ga, In, Ti, Zr, Li, Mg, Ca, Mn, Sc, V, Cr, Fe, and Co.

28. The method of claim 1, wherein the resultant $\text{BN}_x\text{O}_y\text{C}_z$ powder particles comprise a characteristic consisting of at least one member selected from the group of microporous, nanoporous, hollow, dense, high surface area, and low surface area.

29. The method of claim 1, wherein the resultant $\text{BN}_x\text{O}_y\text{C}_z$ powder particles agglomerate at the submicron level.

22

30. The method of claim 1, wherein the resultant $\text{BN}_x\text{O}_y\text{C}_z$ powder particles are intimately mixed with urea formed in situ.

31. A method for preparing h-BN comprising:

providing a boron precursor, an inert carrier gas, and a nitriding agent, wherein said precursor is dissolved in solution, having a solvent selected from the group consisting of non-aqueous solvent and partially aquated solvent, thereby forming a boron precursor solution, wherein partially aquated boron precursor solutions contain less than or equal to 50 wt. % water;

aerosolizing the boron precursor solution;

forming a combined gas stream by introducing the carrier gas into a chamber containing the aerosolized precursor;

heating the combined gas stream in a heated furnace;

introducing the nitriding agent into the furnace; and

reacting the nitriding agent and aerosolized precursor to form a powder of a boron-nitrogen-oxygen-carbon-hydrogen composition; and

forming a boron-nitrogen powder by allowing the nitriding agent and the boron-nitrogen-oxygen-carbon-hydrogen composition to react with the nitriding agent in a second heating step.

32. The method of claim 31 wherein the nitriding agent comprises a member selected from the group consisting of NH_3 , N_2/H_2 , N_2 , alkylamines, hydrazine, cyanamide, dicyanamide, hydroxylamine, urea, and mixtures thereof.

33. The method of claim 31 wherein the boron precursor agent comprises a boron precursor selected from the group consisting of boric acid, boric oxide, ammonium borates, other non-aqueous solvent soluble borates, and mixtures thereof.

34. The method of claim 31 wherein said ammonium borates comprise a member selected from the group consisting of ammonium tetraborate, ammonium pentaborate, ammonium polyborates, and hydrates thereof.

35. The method of claim 31 wherein said non-aqueous solution comprises at least one member selected from the group of solvents consisting of alcohols, ethers, and mixtures thereof.

36. The method of claim 30, wherein the resultant $\text{BN}_x\text{O}_y\text{C}_z$ powder particles comprise a morphology consisting of at least one member selected from the group of microporous, nanoporous, hollow, dense, high surface area, and low surface area.

37. The method of claim 31 wherein in the step of introducing the nitriding agent, the nitriding agent comprises a liquid, and wherein the liquid is aerosolized and is introduced into the furnace by a carrier gas.

38. The method of claim 31 wherein the aerosolized precursor, the carrier gas, and the nitriding agent are simultaneously introduced into the furnace.

39. The method of claim 31 wherein the flow of the combined gas stream has a predetermined low rate.

40. The method of claim 31 wherein in the step of introducing the nitriding agent, the nitriding agent has a predetermined flow rate.

41. The method of claim 31 wherein the step of first heating the furnace comprises the additional step of maintaining a temperature of between approximately 600° C. and approximately 1800° C.

42. The method of claim 41 wherein the temperature is maintained between approximately 1200° C. and approximately 1800° C.

23

43. The method of claim 31 comprising an additional collecting step wherein the boron-nitrogen-oxygen-carbon-hydrogen powder is collected on a collection device.

44. The method of claim 43 wherein the boron-nitrogen-oxygen-carbon-hydrogen powder is collected on a filter.

45. The method of claim 31 comprising the following additional steps in the second heating step;

placing the collected boron-nitrogen-oxygen-carbon-hydrogen powder in a second furnace; and

subjecting the powder to the second heating step in the second furnace.

46. The method of claim 31 comprising an additional collecting step wherein the boron nitride powder is collected on a collection device.

47. The method of claim 46 wherein the boron nitride is collected on a filter.

48. The method of claim 31 comprising the additional steps of venting a gas stream entrained with the boron-nitrogen-oxygen-carbon-hydrogen powder into a second furnace before the second heating step.

49. The method of claim 31 wherein both heating steps are performed in one furnace.

50. The method of claim 49 wherein the one furnace is a vertical furnace.

24

51. The method of claim 31 wherein the second heating step comprises maintaining the temperature between approximately 600° C. and approximately 1800° C.

52. The method of claim 51 wherein in the second heating step the temperature is maintained between approximately 1200° C. and approximately 1800° C.

53. The method of claim 31 wherein modified h-BN particles form morphological characteristics comprising configurations selected from the group consisting of turbostratic structures, bladed spherical particles, platelet particles, and particles having crystalline whisker growth.

54. The method of claim 53 wherein said morphological characteristics are determined by varying at least one condition selected from the group consisting of varying the aerosol conditions and varying the reactor conditions.

55. The method of claim 31 wherein the formed BN particles comprise a diameter range between approximately 0.05 microns and approximately 100 microns.

56. The method of claim 31 wherein the resultant $\text{BN}_x\text{O}_y\text{C}_z$ powder particles are intimately mixed with urea formed in situ.

* * * * *